



Republic of the Philippines
CITY GOVERNMENT OF SAN CARLOS
Province of Negros Occidental

**BIDS AND AWARDS COMMITTEE
(BAC)**

BIDDING DOCUMENTS

FOR

Purchase Request No. 221-23-09-1592

Approved Budget of the Contract (ABC): ₱ 2,779,000.00

Contract Name:

**CONSTRUCTION OF TWO (2) CLASSROOM BUILDING AT LINA DELA VINA
INTEGRATED SCHOOL (PHASE 2), BRGY PALAMPAS, SAN CARLOS CITY,
NEGROS OCCIDENTAL**

With Terms of Reference (TOR) and Project Plan

(First Envelope: Eligibility and Technical Components)

SUBMITTED BY : _____
ADDRESS : _____
CONTACT NO. : _____
EMAIL AD : _____

DATE OF SUBMISSION

INSTRUCTIONS TO BIDDERS

1. Please submit sets of documents completely in two separate envelopes:
The First Envelope (Original, Copy 1 and Copy 2) containing Eligibility & Technical Documents
The Second Envelope (Original, Copy 1 and Copy 2) containing Financial Documents.
2. Check that all annexes are in accordance with the prescribed format and submit it in chronological order.
3. Submit your completed bid documents on or before the time of the opening of bids mentioned below.
4. Electronic submission and receipt of bids is not available pending compliance with GPPB Resolutions.

Compliance of the above is for mutual advantage, i.e. to facilitate a complete and thorough evaluation of your bid documents.

SCHEDULES

Schedule/Place of Re-Bidding

May 28, 2024 @ 1:30 PM
BAC Secretarial Office
2F City Hall Building

Nonrefundable fee of Bidding Documents @ Php 5,000.00

**Bid and Awards Committee
City of San Carlos**

Republic of the Philippines
City Government of San Carlos
Province of Negros Occidental

Contract Name: CONSTRUCTION OF TWO (2) CLASSROOM BUILDING AT LINA DELA VINA INTEGRATED SCHOOL (PHASE 2), BRGY PALAMPAS, SAN CARLOS CITY, NEGROS OCCIDENTAL

Location of the Contract: San Carlos City, Negros Occidental

1. PHILGEPS (Certificate Of Registration And Membership in accordance with Section 8.5.2 Of R.A 9184 - Platinum Membership)

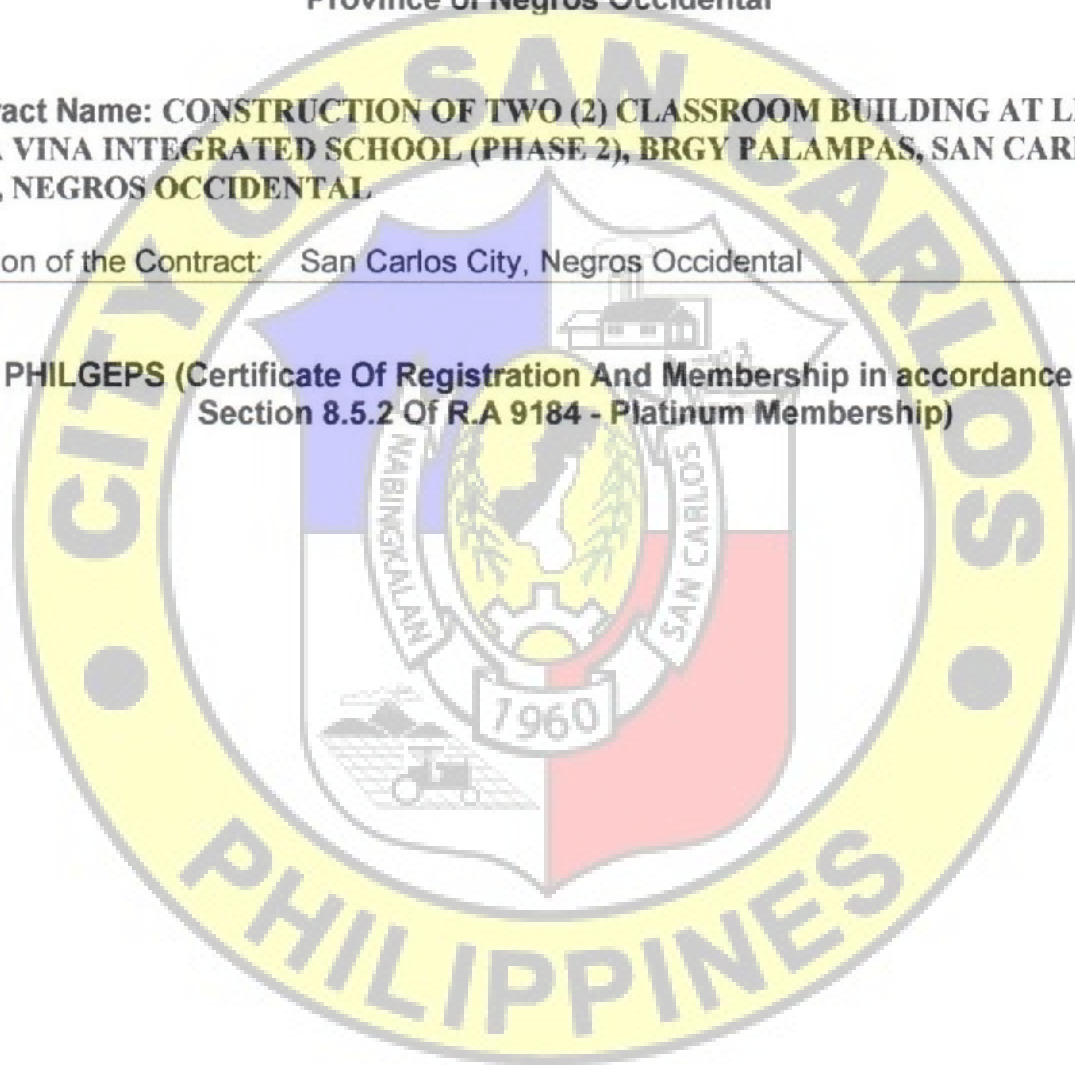

Republic of the Philippines
City Government of San Carlos
Province of Negros Occidental

Contract Name: CONSTRUCTION OF TWO (2) CLASSROOM BUILDING AT LINA DELA VINA INTEGRATED SCHOOL (PHASE 2), BRGY PALAMPAS, SAN CARLOS CITY, NEGROS OCCIDENTAL

Location of the Contract: San Carlos City, Negros Occidental

2. JOINT VENTURE AGREEMENT (JVA), IF APPLICABLE

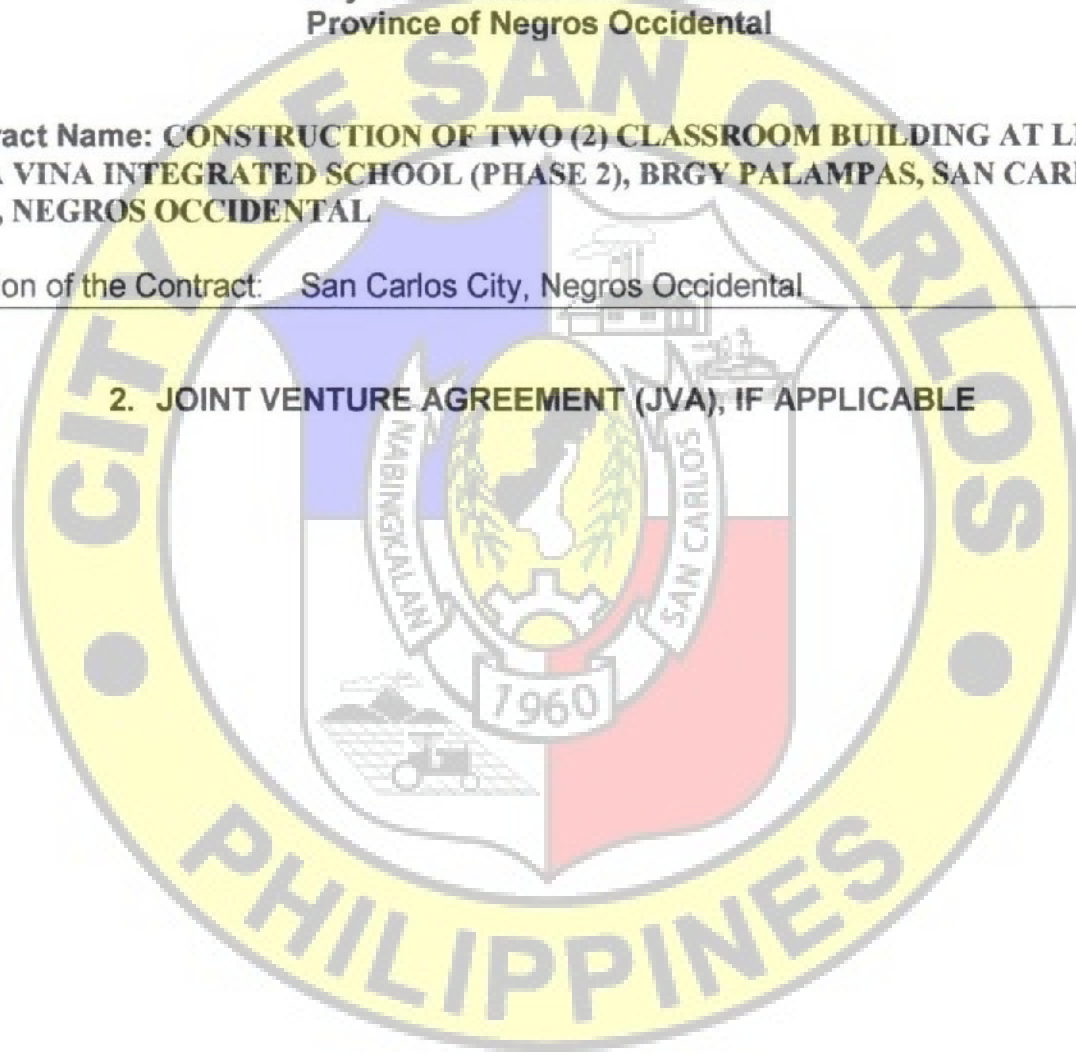

Republic of the Philippines
City Government of San Carlos
Province of Negros Occidental

Contract Name: CONSTRUCTION OF TWO (2) CLASSROOM BUILDING AT LINA DELA VINA INTEGRATED SCHOOL (PHASE 2), BRGY PALAMPAS, SAN CARLOS CITY, NEGROS OCCIDENTAL

Location of the Contract: San Carlos City, Negros Occidental

3. **NFCC BASED ON THE DATA SUBMITTED TO THE BIR THRU ITS EFPS OR COMMITTED LINE OF CREDIT (CLC) FROM A UNIVERSAL OR COMMERCIAL BANK**

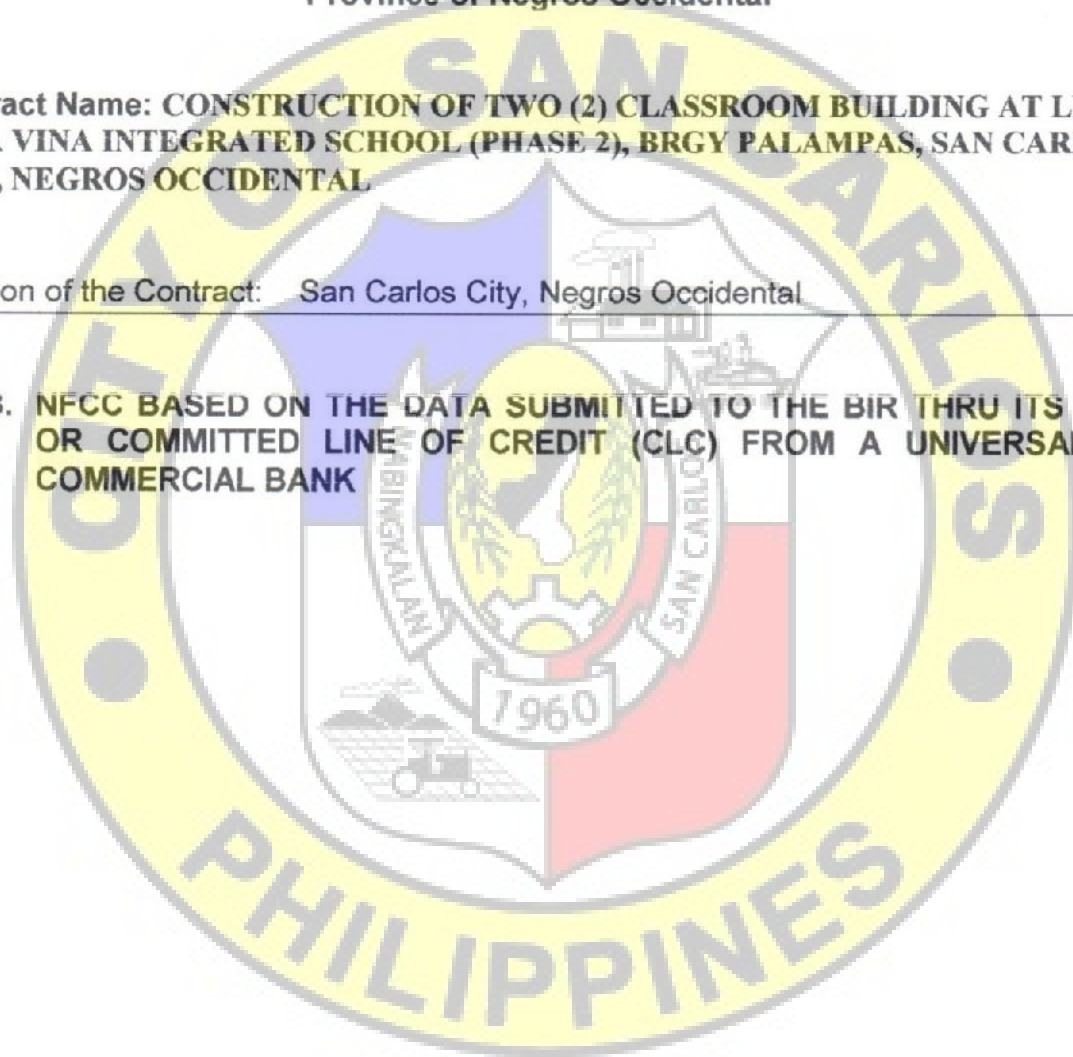

Republic of the Philippines
City Government of San Carlos
Province of Negros Occidental

Contract Name: CONSTRUCTION OF TWO (2) CLASSROOM BUILDING AT LINA DELA VINA INTEGRATED SCHOOL (PHASE 2), BRGY PALAMPAS, SAN CARLOS CITY, NEGROS OCCIDENTAL

Location of the Contract: San Carlos City, Negros Occidental

4. DULY NOTARIZED STATEMENT OF ALL ON-GOING GOVERNMENT AND PRIVATE CONTRACTS

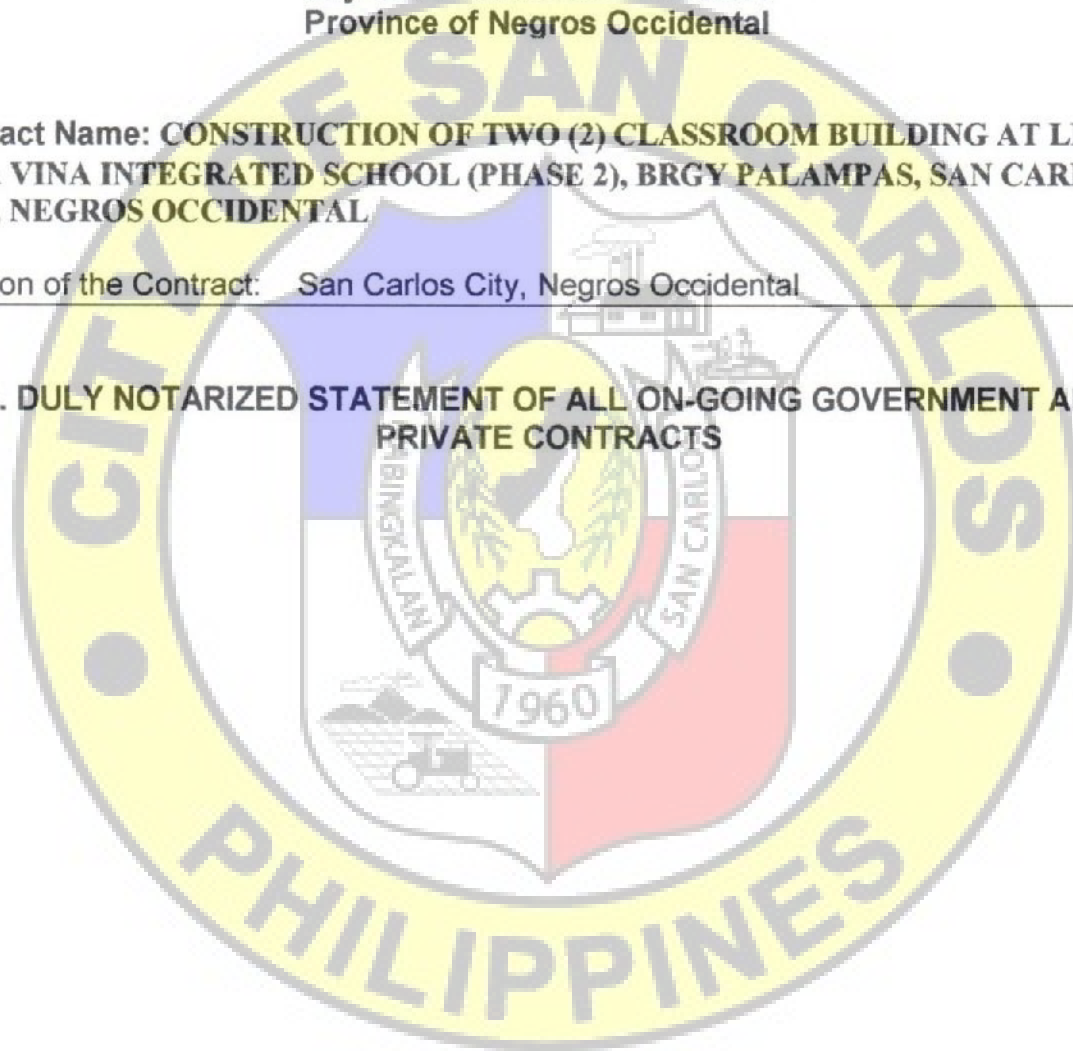

Republic of the Philippines
City Government of San Carlos
Province of Negros Occidental

Contract Name: CONSTRUCTION OF TWO (2) CLASSROOM BUILDING AT LINA DELA VINA INTEGRATED SCHOOL (PHASE 2), BRGY PALAMPAS, SAN CARLOS CITY, NEGROS OCCIDENTAL

Location of the Contract: San Carlos City, Negros Occidental

5. DULY NOTARIZED STATEMENT OF:

- A. At least three (3) Completed Similar Contracts (Government or Private) for the last five (5) years.**
- B. Single Largest Completed Contract (SLCC) at least 50% of the total ABC.**

Republic of the Philippines
City Government of San Carlos
Province of Negros Occidental

Contract Name: CONSTRUCTION OF TWO (2) CLASSROOM BUILDING AT LINA DELA VINA INTEGRATED SCHOOL (PHASE 2), BRGY PALAMPAS, SAN CARLOS CITY, NEGROS OCCIDENTAL

Location of the Contract: San Carlos City, Negros Occidental

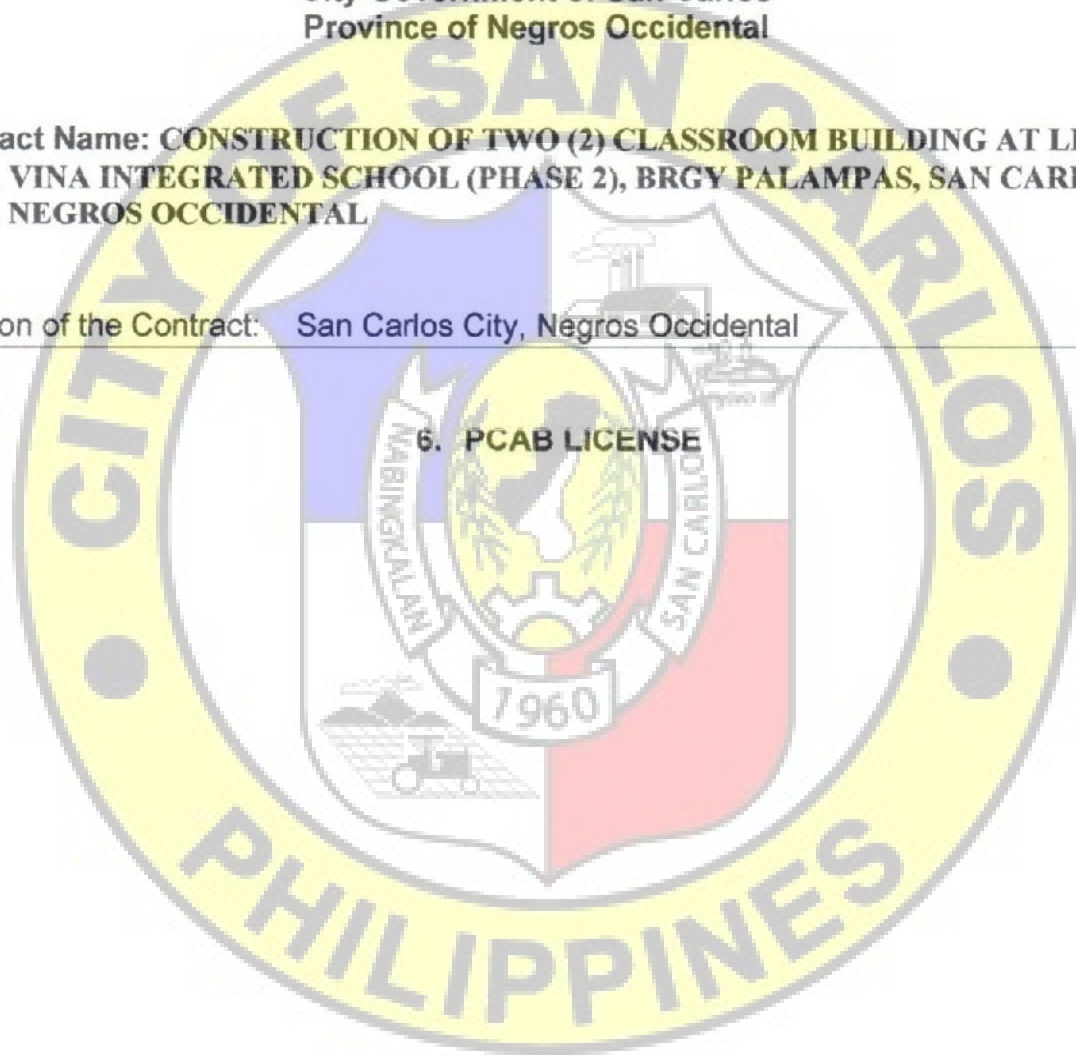

6. PCAB LICENSE

Republic of the Philippines
City Government of San Carlos
Province of Negros Occidental

Contract Name: CONSTRUCTION OF TWO (2) CLASSROOM BUILDING AT LINA DELA VINA INTEGRATED SCHOOL (PHASE 2), BRGY PALAMPAS, SAN CARLOS CITY, NEGROS OCCIDENTAL

Location of the Contract: San Carlos City, Negros Occidental

7. PROJECT REQUIREMENTS:

- a. Organizational Chart for the contract to be bid
- b. List of Contractor's Personnel (Civil Engineer, Skilled laborers [to include Mason, Welder, and Carpenter], and Manual laborers) to be assigned to the contract to be bid with their complete qualification and experience data
- c. List of Contractor's Equipment (owned, leased and/or under purchase agreements, supported by certification of availability of equipment from the equipment lessor/vendor for the duration of the project) to be assigned to the contract to be bid, with their complete qualification and experience data
- d. Duly Notarized Affidavit of Site Inspection (Please see attached Form)

Name of the Procuring Entity

Contract Reference Number
Name of the Contract
Location of the Contract

Standard Form Number: SF-INFR-51
Revised on: August 11, 2004

AFFIDAVIT OF SITE INSPECTION

I, _____ (Representative of the Bidder) _____, of legal age, _____ civil status _____, Filipino and residing at _____ (Address of the Representative) _____, under oath, hereby depose and say:

That I am the _____ (Position in the Bidder) _____ of the _____ (Name of the Bidder) _____, with office at _____ (Address of the Bidder) _____;

That I have inspected the site for _____ (Name of the Contract) _____, located at _____ (Location of the Contract) _____;

That I am making this statement as part of the requirement for the Technical Proposal of the _____ (Name of the Bidder) _____ for _____ (Name of the Contract) _____.

IN FAITH WHEREOF, I hereby affix my signature this _____ day of _____, 20____ at _____, Philippines.

AFFIANT

SUBSCRIBED AND SWORN TO before me this _____, day of _____, 20____, affiant Exhibiting to me his/her Community Tax Certificate No. _____ issued on _____ at _____, Philippines.

(Notary Public)

Until _____
PTR No. _____
Date _____
Place _____
TIN _____

Document No. _____
Page No. _____
Book No. _____
Series of _____

Republic of the Philippines
City Government of San Carlos
Province of Negros Occidental

Contract Name: CONSTRUCTION OF TWO (2) CLASSROOM BUILDING AT LINA DELA VINA INTEGRATED SCHOOL (PHASE 2), BRGY PALAMPAS, SAN CARLOS CITY, NEGROS OCCIDENTAL

Location of the Contract: San Carlos City, Negros Occidental

8. BID SECURITY IN ANY OF THE FOLLOWING FORMS:

- | | |
|---|--|
| a) Cash or cashier's / Manager's Check issued by a Universal or Commercial Bank in favor of the City Treasurer of San Carlos City. | : Two percent (2%) of the ABC |
| b) Bank draft/guarantee or irrevocable letter of credit issued by a Universal or Commercial Bank. Provided, however, that it shall be confirmed or authenticated by a Universal or Commercial Bank. | : Two percent (2%) of the ABC |
| c) Surety Bond callable upon demand issued by a surety or insurance company duly certified by the Insurance Commission as authorized to issue such security. | : Five percent (5%) of the ABC |
| d) Any combination of the foregoing | : Proportionate to share form with respect to total amount of security |
| e) Bid Securing Declaration | |

REPUBLIC OF THE PHILIPPINES
CITY OF SAN CARLOS, NEGROS OCCIDENTAL) S.S.

BID SECURING DECLARATION

Project Identification No. / Purchase Request (PR) No. : 221-23-09-1592

To: *[Insert name and address of the Procuring Entity]*

I/We, the undersigned, declare that:

1. I/We understand that, according to your conditions, bids must be supported by a Bid Security, which may be in the form of a Bid Securing Declaration.
2. I/We accept that: (a) I/we will be automatically disqualified from bidding for any procurement contract with any procuring entity for a period of two (2) years upon receipt of your Blacklisting Order; and, (b) I/we will pay the applicable fine provided under Section 6 of the Guidelines on the Use of Bid Securing Declaration, within fifteen (15) days from receipt of the written demand by the procuring entity for the commission of acts resulting to the enforcement of the bid securing declaration under Sections 23.1(b), 34.2, 40.1 and 69.1, except 69.1(f), of the IRR of RA No. 9184; without prejudice to other legal action the government may undertake.
3. I/We understand that this Bid Securing Declaration shall cease to be valid on the following circumstances:
 - a. Upon expiration of the bid validity period, or any extension thereof pursuant to your request;
 - b. I am/we are declared ineligible or post-disqualified upon receipt of your notice to such effect, and (i) I/we failed to timely file a request for reconsideration or (ii) I/we filed a waiver to avail of said right; and
 - c. I am/we are declared the bidder with the Lowest Calculated Responsive Bid, and I/we have furnished the performance security and signed the Contract.

IN WITNESS WHEREOF, I/We have hereunto set my/our hand/s this ____ day of *[month]* *[year]* at *[place of execution]*.

[Insert NAME OF BIDDER OR ITS AUTHORIZED REPRESENTATIVE]

[Insert signatory's legal capacity]

Affiant

[Jurat]

[Format shall be based on the latest Rules on Notarial Practice]

Republic of the Philippines
City Government of San Carlos
Province of Negros Occidental

Contract Name: CONSTRUCTION OF TWO (2) CLASSROOM BUILDING AT LINA DELA VINA INTEGRATED SCHOOL (PHASE 2), BRGY PALAMPAS, SAN CARLOS CITY, NEGROS OCCIDENTAL

Location of the Contract: San Carlos City, Negros Occidental

9. OMNIBUS SWORN STATEMENT IN ACCORDANCE WITH SECTION 25.3

for
Purchase Request (PR) No. 221-23-09-1592
REPUBLIC OF THE PHILIPPINES)
CITY OF SAN CARLOS, NEGROS OCCIDENTAL) S.S
AFFIDAVIT

I, [Name of Affiant], of legal age, [Civil Status], [Nationality], and residing at [Address of Affiant], after having been duly sworn in accordance with law, do hereby depose and state that:

1. [Select one, delete the other:]

[If a sole proprietorship:] I am the sole proprietor or authorized representative of [Name of Bidder] with office address at [address of Bidder];

[If a partnership, corporation, cooperative, or joint venture:] I am the duly authorized and designated representative of [Name of Bidder] with office address at [address of Bidder];

2. [Select one, delete the other:]

[If a sole proprietorship:] As the owner and sole proprietor, or authorized representative of [Name of Bidder], I have full power and authority to do, execute and perform any and all acts necessary to participate, submit the bid, and to sign and execute the ensuing contract for [Name of the Project] of the [Name of the Procuring Entity], as shown in the attached duly notarized Special Power of Attorney;

[If a partnership, corporation, cooperative, or joint venture:] I am granted full power and authority to do, execute and perform any and all acts necessary to participate, submit the bid, and to sign and execute the ensuing contract for [Name of the Project] of the [Name of the Procuring Entity], as shown in the attached [state title of attached document showing proof of authorization (e.g., duly notarized Secretary's Certificate, Board/Partnership Resolution, or Special Power of Attorney, whichever is applicable)];

3. [Name of Bidder] is not "blacklisted" or barred from bidding by the Government of the Philippines or any of its agencies, offices, corporations, or Local Government Units, foreign government/foreign or international financing institution whose blacklisting rules have been recognized by the Government Procurement Policy Board, **by itself or by relation, membership, association, affiliation, or controlling interest with another blacklisted person or entity as defined and provided for in the Uniform Guidelines on Blacklisting;**

4. Each of the documents submitted in satisfaction of the bidding requirements is an authentic copy of the original, complete, and all statements and information provided therein are true and correct;

5. [Name of Bidder] is authorizing the Head of the Procuring Entity or its duly authorized representative(s) to verify all the documents submitted;

6. *[Select one, delete the rest:]*

[If a sole proprietorship:] The owner or sole proprietor is not related to the Head of the Procuring Entity, members of the Bids and Awards Committee (BAC), the Technical Working Group, and the BAC Secretariat, the head of the Project Management Office or the end-user unit, and the project consultants by consanguinity or affinity up to the third civil degree;

[If a partnership or cooperative:] None of the officers and members of *[Name of Bidder]* is related to the Head of the Procuring Entity, members of the Bids and Awards Committee (BAC), the Technical Working Group, and the BAC Secretariat, the head of the Project Management Office or the end-user unit, and the project consultants by consanguinity or affinity up to the third civil degree;

[If a corporation or joint venture:] None of the officers, directors, and controlling stockholders of *[Name of Bidder]* is related to the Head of the Procuring Entity, members of the Bids and Awards Committee (BAC), the Technical Working Group, and the BAC Secretariat, the head of the Project Management Office or the end-user unit, and the project consultants by consanguinity or affinity up to the third civil degree;

7. *[Name of Bidder]* complies with existing labor laws and standards; and

8. *[Name of Bidder]* is aware of and has undertaken the responsibilities as a Bidder in compliance with the Philippine Bidding Documents, which includes:

- a. Carefully examining all of the Bidding Documents;
- b. Acknowledging all conditions, local or otherwise, affecting the implementation of the Contract;
- c. Making an estimate of the facilities available and needed for the contract to be bid, if any; and
- d. Inquiring or securing Supplemental/Bid Bulletin(s) issued for the *[Name of the Project]*.

9. *[Name of Bidder]* did not give or pay directly or indirectly, any commission, amount, fee, or any form of consideration, pecuniary or otherwise, to any person or official, personnel or representative of the government in relation to any procurement project or activity.

10. **In case advance payment was made or given, failure to perform or deliver any of the obligations and undertakings in the contract shall be sufficient grounds to constitute criminal liability for Swindling (Estafa) or the commission of fraud with unfaithfulness or abuse of confidence through misappropriating or converting any payment received by a person or entity under an obligation involving the duty to deliver certain goods or services, to the prejudice of the public and the government of the Philippines pursuant to Article 315 of Act No. 3815 s. 1930, as amended, or the Revised Penal Code.**

IN WITNESS WHEREOF, I have hereunto set my hand this ___ day of ___, 20__ at _____, Philippines.

[Insert NAME OF BIDDER OR ITS AUTHORIZED REPRESENTATIVE]

[Insert signatory's legal capacity]

Affiant

[Jurat]

[Format shall be based on the latest Rules on Notarial Practice]



Republic of the Philippines
CITY GOVERNMENT OF SAN CARLOS
Province of Negros Occidental

**BIDS AND AWARDS COMMITTEE
(BAC)**

BIDDING DOCUMENTS

FOR

Purchase Request No. 221-23-09-1592

Approved Budget of the Contract (ABC): ₱ 2,779,000.00

Contract Name:

**CONSTRUCTION OF TWO (2) CLASSROOM BUILDING AT LINA DELA VINA
INTEGRATED SCHOOL (PHASE 2), BRGY PALAMPAS, SAN CARLOS CITY,
NEGROS OCCIDENTAL**

With Terms of Reference (TOR) and Project Plan

(Second Envelope: Financial Component)

SUBMITTED BY : _____
ADDRESS : _____
CONTACT NO. : _____
EMAIL AD : _____

DATE OF SUBMISSION

INSTRUCTIONS TO BIDDERS

1. Please submit sets of documents completely in two separate envelopes:
The First Envelope (Original, Copy 1 and Copy 2) containing Eligibility & Technical Documents
The Second Envelope (Original, Copy 1 and Copy 2) containing Financial Documents.
2. Check that all annexes are in accordance with the prescribed format and submit it in chronological order.
3. Submit your completed bid documents on or before the time of the opening of bids mentioned below.
4. Electronic submission and receipt of bids is not available pending compliance with GPPB Resolutions.

Compliance of the above is for mutual advantage, i.e. to facilitate a complete and thorough evaluation of your bid documents.

SCHEDULES

Schedule/Place of Re-Bidding

May 28, 2024 @ 1:30 PM
BAC Secretarial Office
2F City Hall Building

Nonrefundable fee of Bidding Documents @ Php 5,000.00

**Bid and Awards Committee
City of San Carlos**

Republic of the Philippines
City Government of San Carlos
Province of Negros Occidental

Contract Name: CONSTRUCTION OF TWO (2) CLASSROOM BUILDING AT LINA DELA VIÑA INTEGRATED SCHOOL (PHASE 2), BRGY PALAMPAS, SAN CARLOS CITY, NEGROS OCCIDENTAL

Location of the Contract: San Carlos City, Negros Occidental

CHECKLIST OF FINANCIAL PROPOSALS/REQUIREMENTS

1. Duly Signed Form of Bid
2. Duly Signed Bid Price in the Bill of Quantities
3. Duly Signed Detailed Estimates
4. Duly Signed Cash flow by quarter and payment schedule

Republic of the Philippines
City Government of San Carlos
Province of Negros Occidental

Contract Name: CONSTRUCTION OF TWO (2) CLASSROOM BUILDING AT LINA DELA VIÑA INTEGRATED SCHOOL (PHASE 2), BRGY PALAMPAS, SAN CARLOS CITY, NEGROS OCCIDENTAL

Location of the Contract: San Carlos City, Negros Occidental

1. DULY SIGNED BID FORM

Date : _____

Project Identification / Purchase Request No. : 221-23-09-1592

To: *[name and address of Procuring Entity]*

Having examined the Philippine Bidding Documents (PBDs) including the Supplemental or Bid Bulletin Numbers *[insert numbers]*, the receipt of which is hereby duly acknowledged, we, the undersigned, declare that:

- a. We have no reservation to the PBDs, including the Supplemental or Bid Bulletins, for the Procurement Project: *[insert name of contract]*;
- b. We offer to execute the Works for this Contract in accordance with the PBDs;
- c. The total price of our Bid in words and figures, excluding any discounts offered below is: *[insert information]*;
- d. The discounts offered and the methodology for their application are: *[insert information]*;
- e. The total bid price includes the cost of all taxes, such as, but not limited to: *[specify the applicable taxes, e.g. (i) value added tax (VAT), (ii) income tax, (iii) local taxes, and (iv) other fiscal levies and duties]*, which are itemized herein and reflected in the detailed estimates,
- f. Our Bid shall be valid within the a period stated in the PBDs, and it shall remain binding upon us at any time before the expiration of that period;
- g. If our Bid is accepted, we commit to obtain a Performance Security in the amount of *[insert percentage amount]* percent of the Contract Price for the due performance of the Contract, or a Performance Securing Declaration in lieu of the the allowable forms of Performance Security, subject to the terms and conditions of issued GPPB guidelines¹ for this purpose;
- h. We are not participating, as Bidders, in more than one Bid in this bidding process, other than alternative offers in accordance with the Bidding Documents;
- i. We understand that this Bid, together with your written acceptance thereof included in your notification of award, shall constitute a binding contract between us, until a formal Contract is prepared and executed; and
- j. We understand that you are not bound to accept the Lowest Calculated Bid or any other Bid that you may receive.
- k. We likewise certify/confirm that the undersigned, is the duly authorized representative of the bidder, and granted full power and authority to do, execute and perform any and all acts necessary to participate, submit the bid, and to sign and execute the ensuing contract for the *[Name of Project]* of the *[Name of the Procuring Entity]*.
- l. We acknowledge that failure to sign each and every page of this Bid Form, including the Bill of Quantities, shall be a ground for the rejection of our bid.

Name: _____

Legal Capacity: _____

Signature: _____

Duly authorized to sign the Bid for and behalf of: _____

Date: _____

Republic of the Philippines
City Government of San Carlos
Province of Negros Occidental

Contract Name: CONSTRUCTION OF TWO (2) CLASSROOM BUILDING AT LINA DELA VIÑA INTEGRATED SCHOOL (PHASE 2), BRGY PALAMPAS, SAN CARLOS CITY, NEGROS OCCIDENTAL

Location of the Contract: San Carlos City, Negros Occidental

2. DULY SIGNED BID PRICE IN THE BILL OF QUANTITIES

(Columns (1), (2) and (3) are to be filled up by the Procuring Entity)			(Columns (4) and (5) are to be filled up by the Bidder)	
DESCRIPTION	UNIT	QTY	UNIT PRICE (PESOS)	AMOUNT (PESOS)
(1)	(2)	(3)	(4)	(5)
I Mobilization	Lot	1.0	In words: Pesos	In words: Pesos
			In figures: PHP	In figures: PHP
II Concrete and Masonry Works	Cu.m.	40.0	In words: Pesos	In words: Pesos
			In figures: PHP	In figures: PHP
III Roof Framing and Roofing Works	Sq.m	273.0	In words: Pesos	In words: Pesos
			In figures: PHP	In figures: PHP
IV Ceiling Works	Sq.m	252.0	In words: Pesos	In words: Pesos
			In figures: PHP	In figures: PHP
V Tile Works	units	2.0	In words: Pesos	In words: Pesos
			In figures: PHP	In figures: PHP
VI Painting Works	Sq.m.	189.0	In words: Pesos	In words: Pesos
			In figures: PHP	In figures: PHP
VII Doors and Windows	Units	2.0	In words: Pesos	In words: Pesos
			In figures: PHP	In figures: PHP
VIII Plumbing Works	Units	2.0	In words: Pesos	In words: Pesos
			In figures: PHP	In figures: PHP

				In words: Pesos _____	In words: Pesos _____
IX	Electrical Works	Sq.m.	189.0	In figures: PHP _____	In figures: PHP _____
X	Stairs and Railings	Lot	1.0	In words: Pesos _____	In words: Pesos _____
				In figures: PHP _____	In figures: PHP _____
XI	Chalkboard	Units	2.0	In words: Pesos _____	In words: Pesos _____
				In figures: PHP _____	In figures: PHP _____
XII	Demobilization	Lot	1.0	In words: Pesos _____	In words: Pesos _____
				In figures: PHP _____	In figures: PHP _____
				TOTAL BID COST _____	In words: Pesos _____
					In figures: PHP _____

Submitted by:

Name of the Representative of the Bidder

Position

Name of the Bidder Company

Date: _____

Republic of the Philippines
City Government of San Carlos
Province of Negros Occidental

Contract Name: CONSTRUCTION OF TWO (2) CLASSROOM BUILDING AT LINA DELA VIÑA INTEGRATED SCHOOL (PHASE 2), BRGY PALAMPAS, SAN CARLOS CITY, NEGROS OCCIDENTAL

Location of the Contract: San Carlos City, Negros Occidental

3. DULY SIGNED DETAILED ESTIMATES

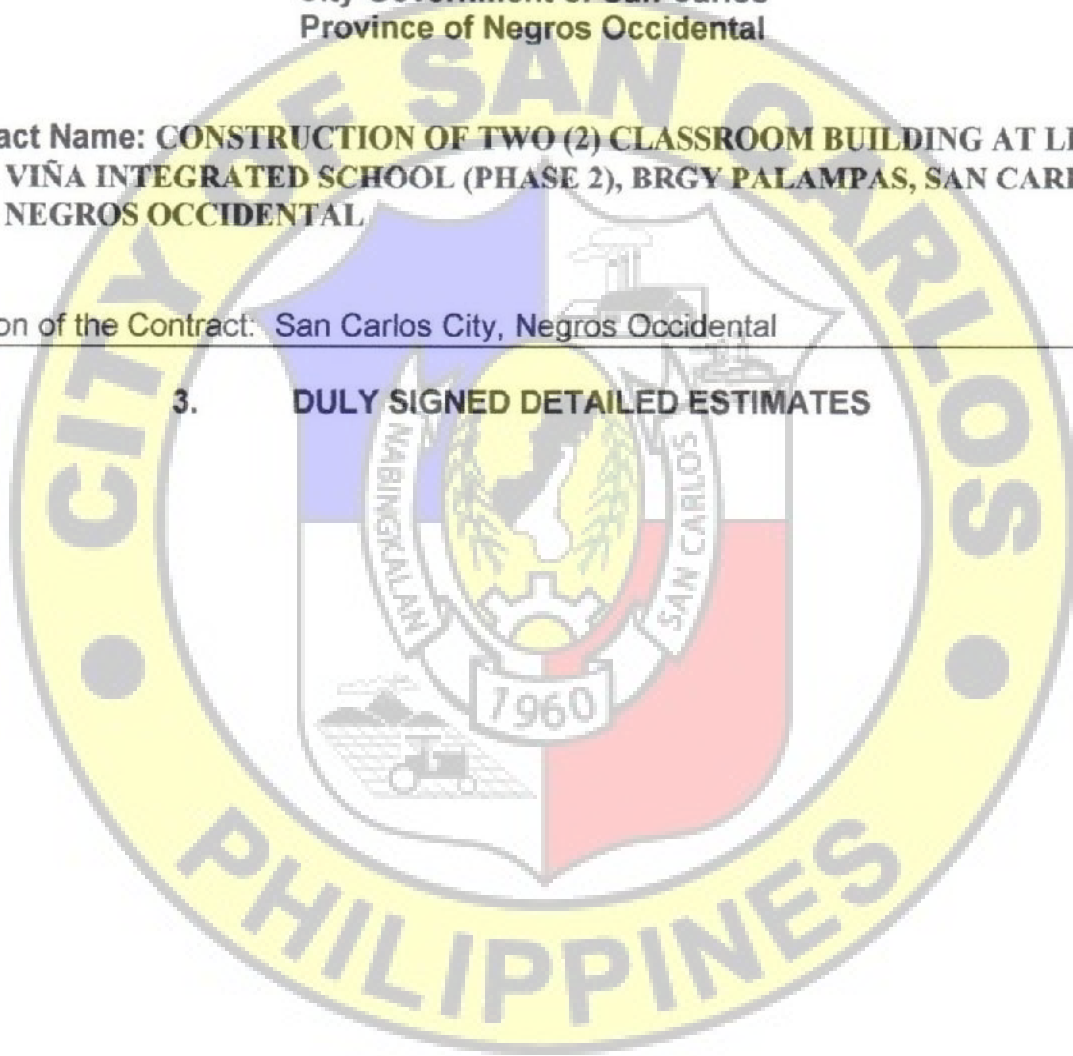

Republic of the Philippines
City Government of San Carlos
Province of Negros Occidental

Contract Name: CONSTRUCTION OF TWO (2) CLASSROOM BUILDING AT LINA DELA VIÑA INTEGRATED SCHOOL (PHASE 2), BRGY PALAMPAS, SAN CARLOS CITY, NEGROS OCCIDENTAL

Location of the Contract: San Carlos City, Negros Occidental

4. DULY SIGNED CASH FLOW BY QUARTER AND PAYMENT SCHEDULE

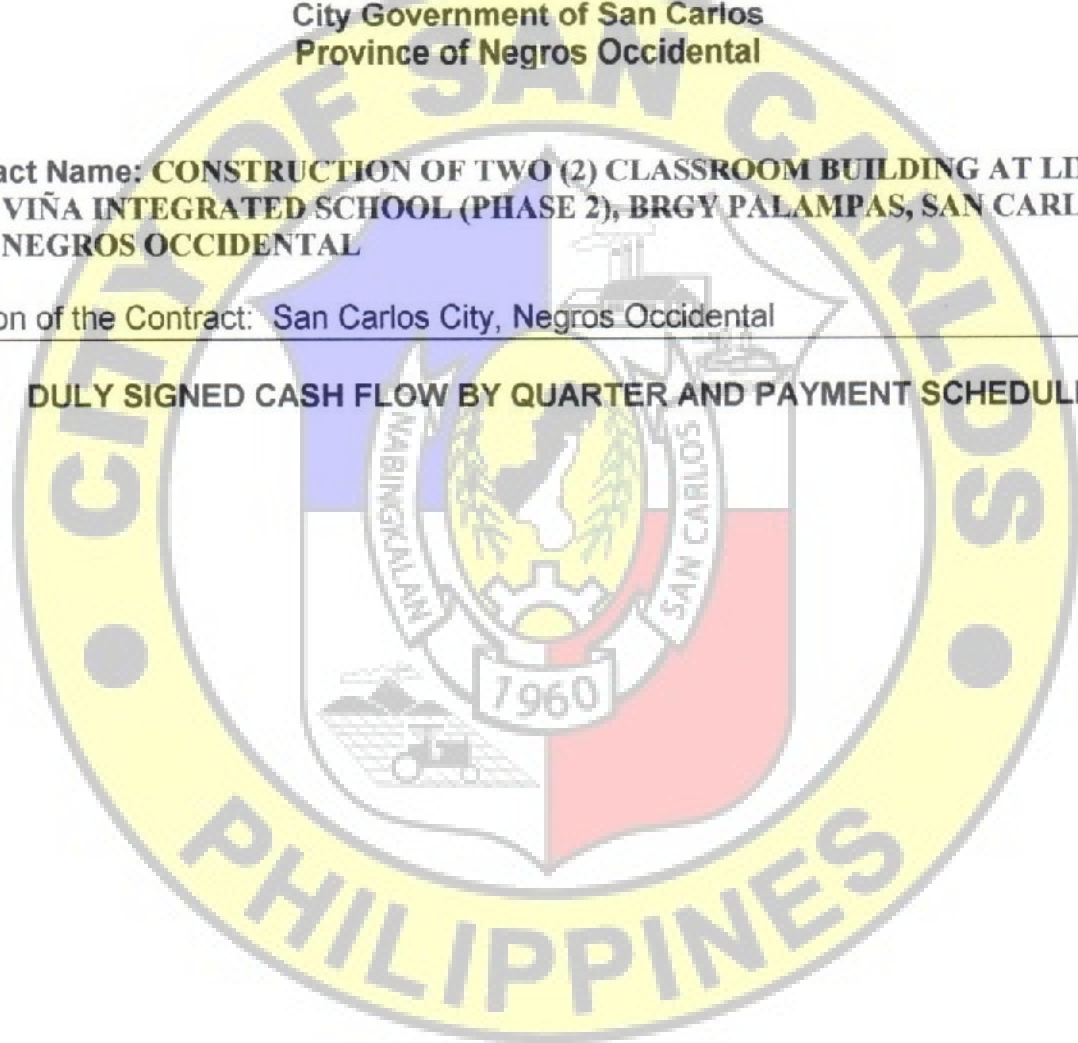

APPROVAL PAGE

**CONSTRUCTION OF TWO (2) CLASSROOM BUILDING AT LINA DELA VIÑA
INTEGRATED SCHOOL (PHASE 2), BRGY PALAMPAS, SAN CARLOS CITY,
NEGROS OCCIDENTAL**

(P 2,779,000.00)

TERMS OF REFERENCE

City of San Carlos
Province of Negros Occidental

Prepared by:

John Leur C. Virtucio

Engineer I

Reviewed by:

Magnolia B. Antonio, EnP

OIC - City Engineer

Approved by:

Renato Y. Gustilo

City Mayor

9

Republic of the Philippines

City of San Carlos

Province of Negros Occidental

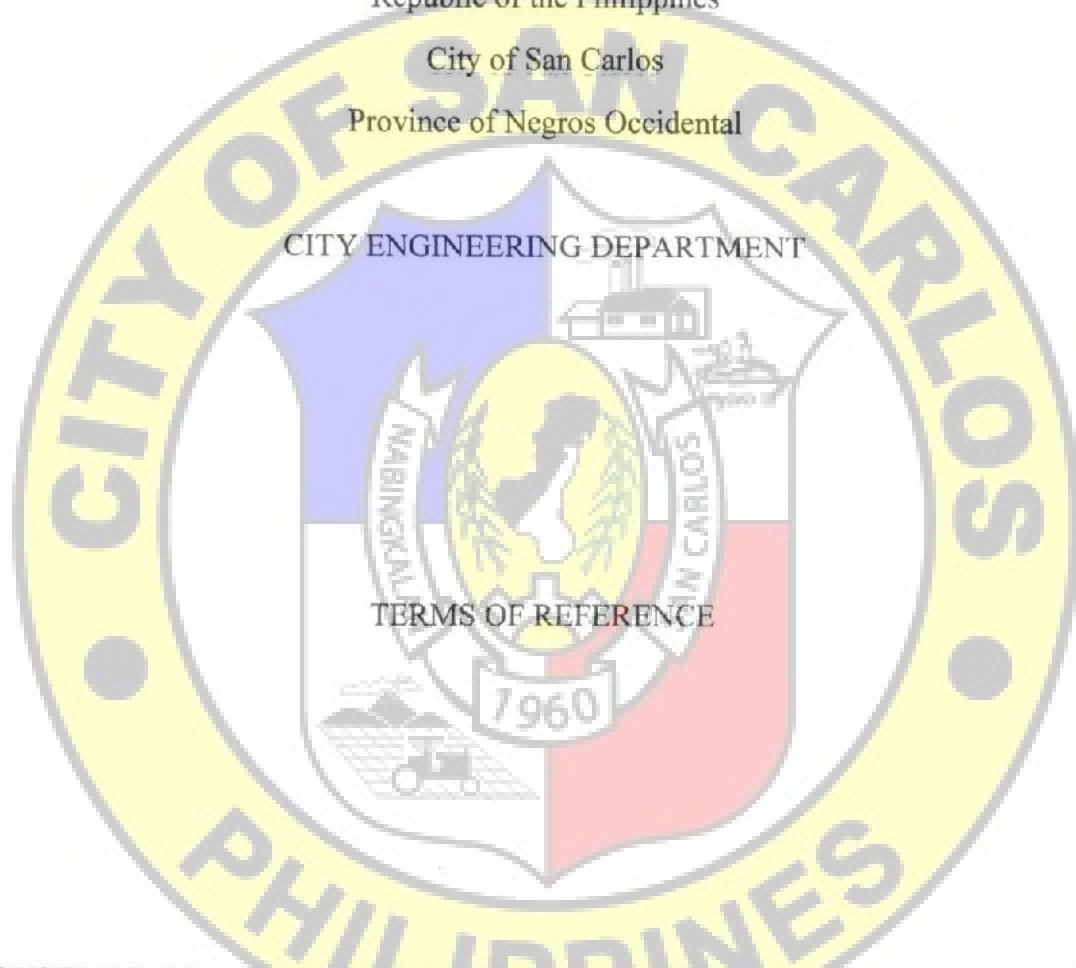

**CONSTRUCTION OF TWO (2) CLASSROOM BUILDING AT LINA DELA VIÑA
INTEGRATED SCHOOL (PHASE 2), BRGY PALAMPAS, SAN CARLOS CITY,
NEGROS OCCIDENTAL**

(P 2,779,000.00)

TABLE OF CONTENTS

A. Background	4
B. General Objective	4
C. The Bidder/Contractor	4
D. The Requirements	4
E. Delivery/Completion	8
F. Manpower Requirement	8
G. Warranty	8
H. Payment Scheme	8



[Handwritten signature]

[Handwritten signature]

A. Background

The City Government through the City Engineering Department continuously construct classrooms and school buildings to provide a very comprehensive learning experience with close supervision by experienced and qualified faculty members.

B. General Objectives

The objective of the construction program of the DepEd is to focus on making connections for students, allowing them to engage in relevant, meaningful activities that can be connected to real life. It aims to connect the theory learned in the classroom, with practical, real life knowledge and experiences.

C. The Bidder

The bidder should have an experience in the construction of at least a two-storey school building.

D. The Requirements

1. Scope of Works

General Conditions

- The project is a construction of 2-classroom building (second floor) on top a finished 2-classroom building structure (ground floor).
- All plans and specifications shall be provided by the end-user.
- The work to be executed in this project shall include Mobilization and demobilization, concrete and masonry works, Roofing and Roof framing works, ceiling works, tile works, painting works, doors and windows, plumbing works, stairs and Railings and chalkboard.
- The contractor shall make sure that the existing adjacent structures shall be protected from damage during construction. If there be any damages on the existing adjacent structure during the construction, the contractor is responsible for restoring the damages.
- All workmanship and materials used in the project shall be of quality standard and in accordance with the technical specifications, plans, and other requirements
- All workmanship, materials and fixtures shall be subjected for inspection by the Engineer/Project in charged that may check and ask for samples of materials to be used for the said project.
- Construction safety and health protocols should be observed at all times by the contractor during the duration of the project.
- Clean up of the construction site after the project shall be the responsibility of the contractor.

2. Material Specifications

CONCRETE AND MASONRY WORKS

Portland Cement	290 bags
Washed Sand	25 cu.m.
Crushed Gravel	20 cu.m.
CHB 4: x 8" x 16"	1800 pcs
10mm DRSB	380 lgths
12mm DRSB	200 lgths
RL 2"x2"x8"	500 lgths
Ordinary Plywood 1/2"	20 shts
Gl tie Wire	50 kg
CW Nails Assorted	38 kg
Concrete Nails Assorted	20 kg
Consumables	1 lot
Tools and Equipments	1 lot

ROOFING FRAMING AND ROOFING WORKS

Angle bar 1.5"x1.5"x 3/16"	40 lgths
Angle bar 1"x1"x 3/16"	30 lgths
Angle bar 1"x1"x 1/8"	42 lgths
C-Purlins 2" x 6" x No.16	30 lgths
C-Purlins 2" x 3" x No.16	88 lgths
10mm DRSB	20 lgths
12mm DRSB	10 lgths
Welding Electrode	50 kg
Rib Type Roofing 0.4mm x 1.0m x L.S.	345 ln.m.
Ridge Roll 0.40mm x 18" x 2.44m	10 pcs
Metal Facsia 0.40mm x 18" x 2.44m	12 pcs
Flashing Facsia Cover 0.40mm x 18" x 2.44m	12 pcs
Metal Facsia 0.40mm x 24" x 2.44m	18 pcs
Teks Screw 2"	2500 pcs
Blind Revits 5/32"	3 box
Consumables	1 lot
Tools and Equipments	1 lot

CEILING WORKS

Fiber Cement Board 4' x 8' x 3/16"	90 shts
Double Furring	180 lgths
Carrying Channel	70 lgths
Wall Angle	60 lgths
W-Clip	500 pcs
Job Screw	3000 pcs
Fiber Cement Board Screw	4000 pcs
Diamond Cutting Disc	2 pcs
Consumables	1 lot
Tools and Equipments	1 lot

TILE WORKS

30 x 30cm Non Skid Floor Tiles	50 pcs
30 x 30cm Gloss Wall tiles	260 pcs
Portland Cement	14 bags
Washed Sand	1 cu.m.
Tile Adhesive	5 bags
Consumables	1 lot
Tools and Equipments	1 lot

PAINTING WORKS

Acrylic Primer	24 gals
Acrylic Reducer	4 gals
Semi Gloss Latex white	24 gals
Flat Latex white	16 gals
Body Filler	8 gals
Marine Epoxy	2 gals
QDE White	8 gals
Red Oxide Metal Primer	3 gals
Paint Thinner	2 gals
Tinting Color latex, raw sienna	50 cans
Tinting Color oil, thalo green	20 cans
Skimcoat	30 bags
Patching Compound	16 kg
Paint Roller 4"	20 pcs
Paint Brush 2"	20 pcs
Sand Paper #80	50 shts
Consumables	1 lot

DOORS AND WINDOWS

Flush Door 0.90 x 2.10m	4 units
Door Jamb 2" x 6"	4 units
PVC Door 0.60m x 2.10m	2 sets
Door Lock set	6 pcs
Loose Pin Hinges 3.5" x 3.5"	6 sets
Jalouplus Windows	20 sq.m.
Consumables	1 lot

PLUMBING WORKS

Back Tank type Water Closet with complete accessories	2	set
Lavatory Ceramic with accessories	2	sets
Faucet, best quality	2	units
pvc tee 4x4	10	pcs
pvc elbow 4x90	10	pcs
pvc elbow 4 x 45	10	pcs
pvc solvent 200cc	10	can
pvc pipe 4" sc 900	18	lgths
pvc pipe 2" sc 900	12	lgths
pvc elbow 1/2 x 90 threaded blue	8	pcs
pvc elbow 1/2 x 90 plain blue	8	pcs
pvc tee 1/2 threaded blue	15	pcs
pvc tee 1/2 plain blue	16	pcs
pvc mail adaptor blue	30	pcs
pvc female adaptor blue	20	pcs
plumbing tape	20	pcs

ELECTRICAL WORKS

THHN Stranded wire No.8 (150m/roll)	1 roll
THHN Stranded wire No.10 (150m/roll)	2 roll
THHN Stranded wire No.12 (150m/roll)	3 roll
THHN Stranded wire No.14 (150m/roll)	3 roll
Circuit Breaker 30 Amperes	2 pcs
Pinlight Housing 4" for classrooms	22 pcs
12W LED Bulb for classrooms	22 pcs
Flexible hose 1" (100m/roll)	4 roll
Electrical Moulding 1"	10 lgths
3 gang convenience outlet flush mount type	4 pcs
2 gang switch flush mount type	4 pcs
Electrical Conduit 20mm dia. x 3m	12 lgths
Electrical Conduit 25mm dia. x 3m	12 lgths
Electrical Conduit 50mm dia. x 3m	12 lgths
Utility box 2"x4"	50 pcs
Junction box Octagon	30 pcs
Electrical Tape Big	20 pcs

STAIRS AND RAILINGS

Portland Cement	120 bags
Washed Sand	8 cu.m.
Crushed Gravel	8 cu.m.
CHB 4: x 8" x 16"	350 pcs
10mm DRSB	100 lgths
12mm DRSB	120 lgths
GI Pipe 3" Sch.40 Hand Rails	4 lgths
GI Pipe 2" Sch. 40 Post	8 lgths
RL 2"x2"x8"	200 lgths
Ordinary Plywood 1/2"	10 shts
GI tie Wire	10 kg
Welding Electrode	50 kg
CW Nails Assorted	5 kg
Concrete Nails Assorted	5 kg
Consumables	1 lot
Tools and Equipments	1 lot

CHALKBOARD

Ordinary Plywood 4' x 8' x 1/4"	6 shts
S4S Lumber 2'x2'x8"	30 lgths
S4S Lumber 1'x2'x8"	20 lgths
Assorted Finishing Nails	10 kg
Assorted Common wire Nails	10 kg
Consumables	1 lot
Tools and Equipments	1 lot

E. Delivery / Completion

Delivery/completion shall be within 120 calendar days.

F. Man Power Requirement

Manpower for the project shall be at least of the following;

- a. One Civil Engineer
- b. Skilled Laborers
- c. Manual Laborers

G. Warranty

Warranty shall be for a period of one year from the turn-over of the completed project.



H. Payment Scheme

The city has allocated a budget of Two Million, Seven Hundred Seventy-nine thousand Pesos (2,779,000.00Php) for the project. The winning bidder shall be paid in accordance with **R.A. 9184** and other relevant laws.



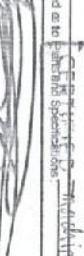

P E R S P E C T I V E

Prepared by: CED <small>WILSON C. YREBEROS CIVIL ENGINEER - 1</small>	Project Title: CONSTRUCTION OF TWO CLASSROOM BUILDING @ LINA DELA VINA INTEGRATED SCHOOL <small>Location : BRGY. PALAMPAS SAN CARLOS CITY, NEG. OCC.</small>	Prepared by:  ENGR. JOHN FAIR VIRTUCIO <small>ENGINEER - 1</small>	Checked by:  ENGR. JUSTINE J. EJERCITO <small>ENGINEER IV</small>	Recommended by (Special):  ENGR. MAGNOLIA B. ANTONIO <small>OIC/ CITY ENGINEER</small>	Approved as to Special: <input checked="" type="checkbox"/> Approved  HON. REMANDO Y. GUSTING <small>CITY MAYOR</small>	Date: _____ Sheet No. A1 / 5
---	---	--	--	---	---	---

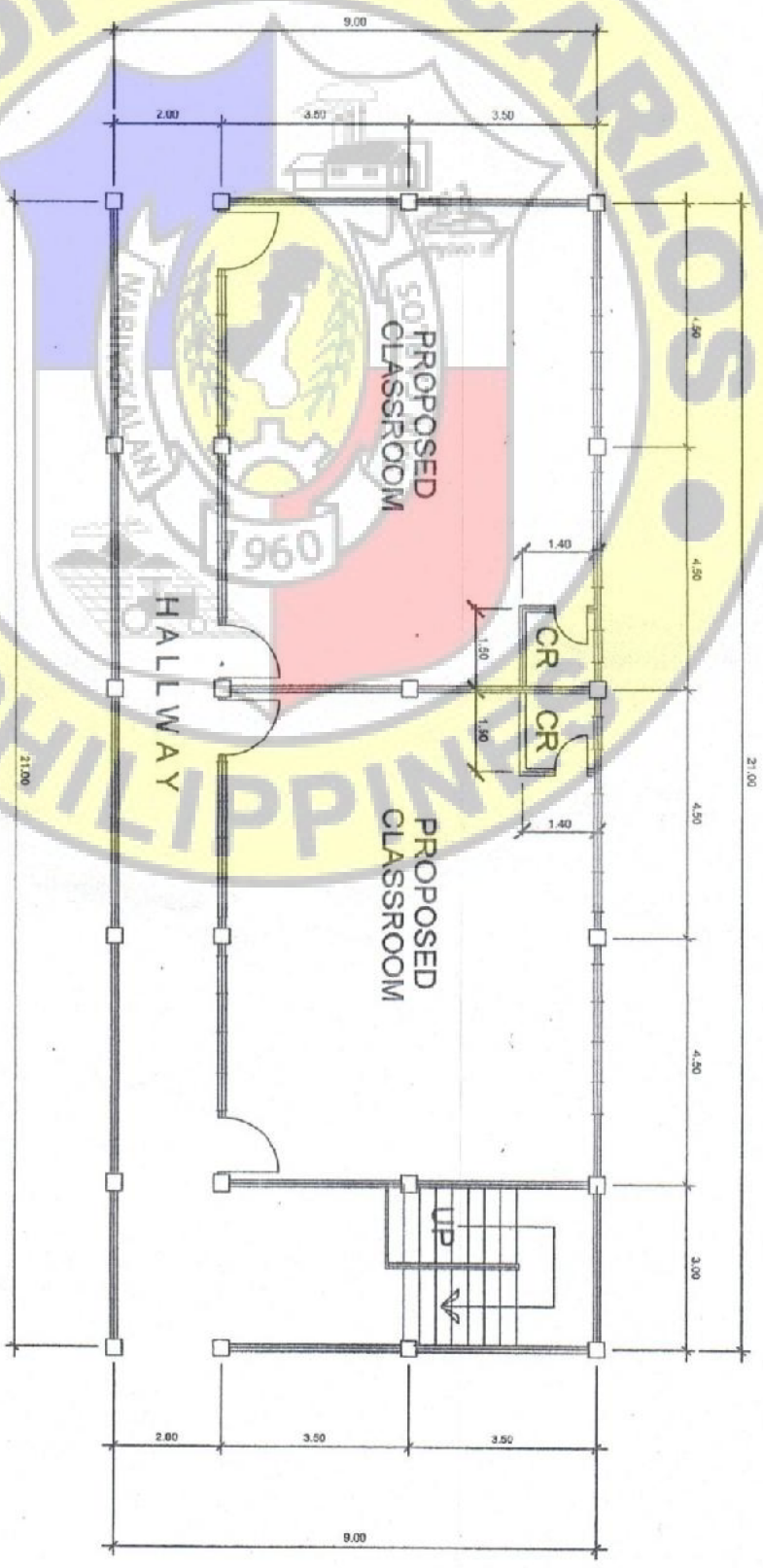
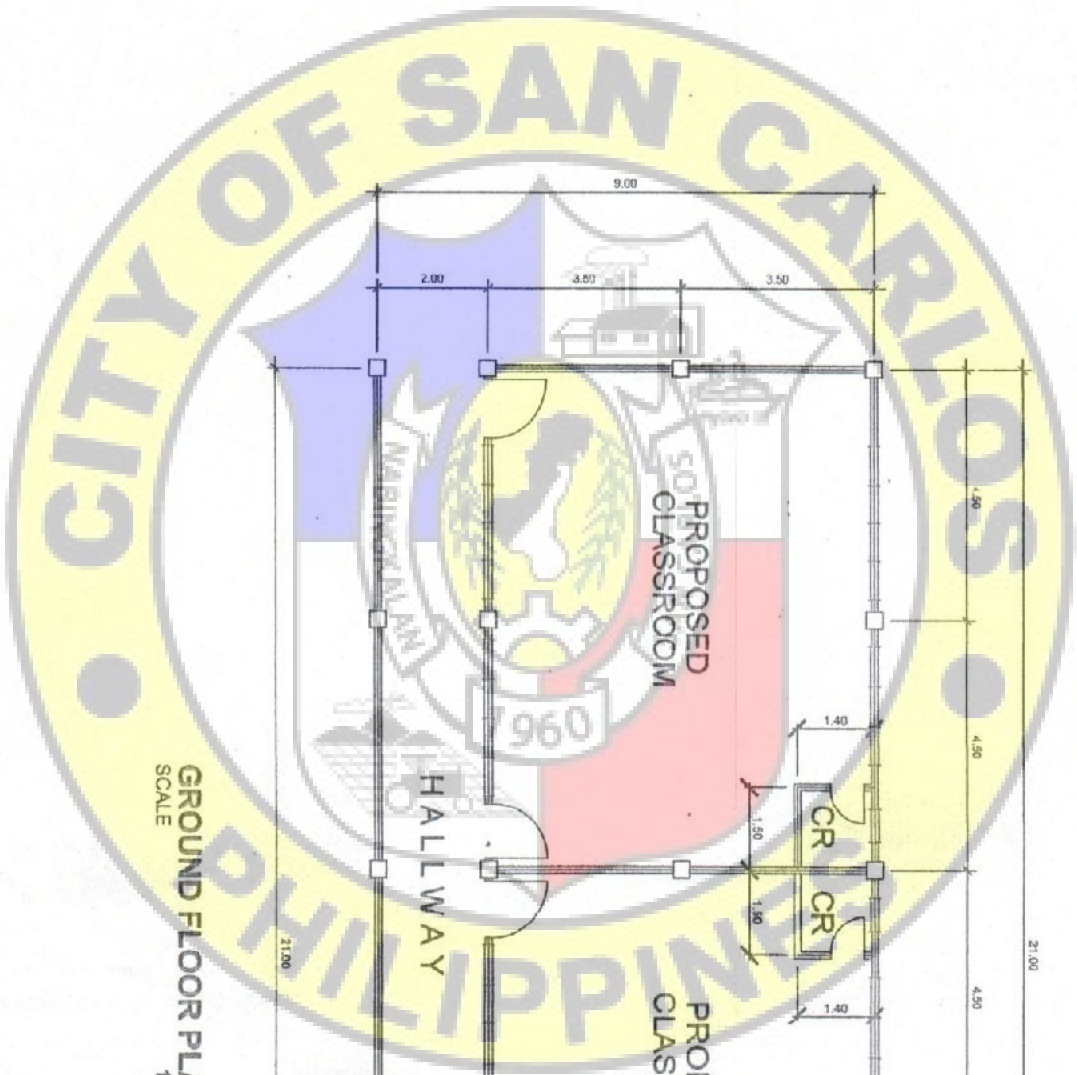

GROUND FLOOR PLAN
SCALE 1:100

From the office of:		Project Title:		Prepared:		Checked:		Recommended/Approved:		Approved as to Plans and Specifications:	
CED		CONSTRUCTION OF TWO CLASSROOM BUILDING @ LINA DELA VIÑA INTEGRATED SCHOOL		ENGR. JOHANN LEUR VIRTUCIO ENGINEER - 1		ENGR. JUSTINE J. EJERCITO ENGINEER IV		ENGR. MAGNOLA B. ANTONIO/ENP OIC/ CITY ENGINEER		HON. RICHARD Y. GUSTILO CITY MAYOR	
Drawn by: TISHA C. TREJOS DRAFTSMAN - 1		Location: BRGY. PALAMAS, SAN CARLOS CITY, NEG. OCC.								<p>COPIED</p> <p>COPIED</p> <p>A2</p> <p>5</p>	

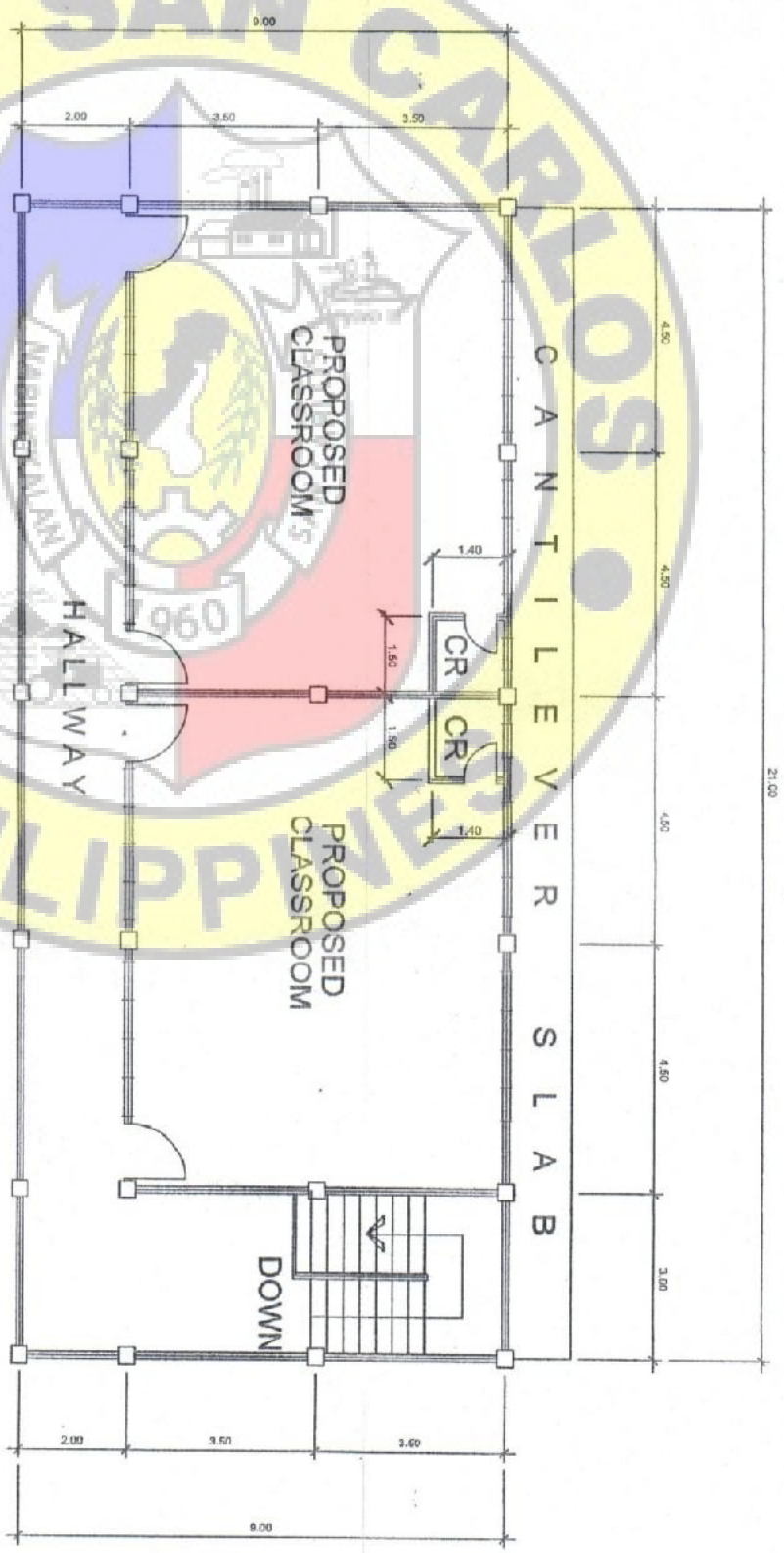
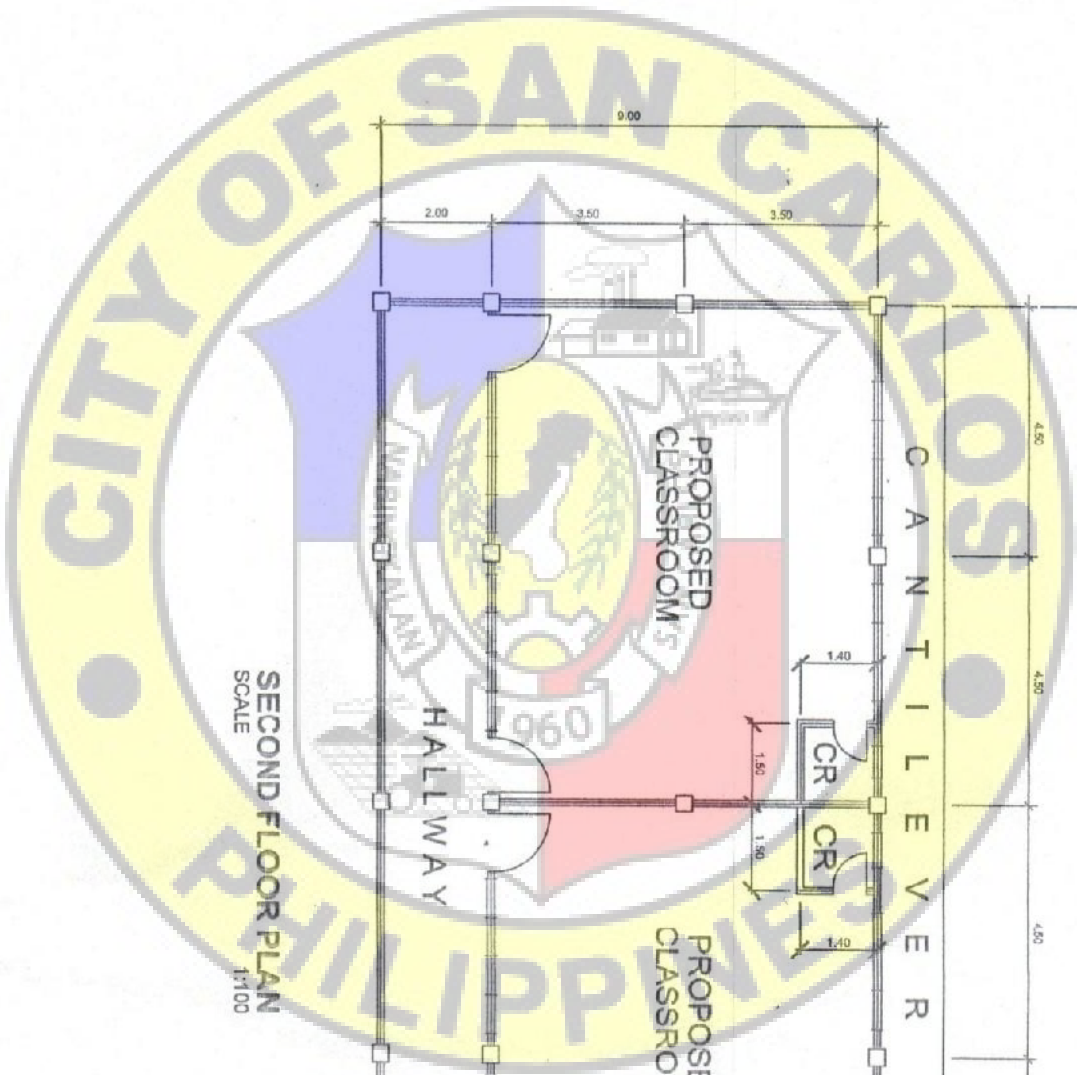

SECOND FLOOR PLAN
SCALE 1:100

From the office of: **Prepared:** **Checked:** **Recommended for Approval:** **Approved as to Plans and Specifications:** **Submitted:**

<p>From the office of: CED RISHA C. TREEROS PRACTICING-1</p>	<p>Project Title: CONSTRUCTION OF TWO CLASSROOM BUILDING @ LINA DELA VINA INTEGRATED SCHOOL Location: BRGY. PALAMPAS, SAN CARLOS CITY, NEG. OCC.</p>	<p>Prepared: ENGR. JOHN LEAF VIRTUCIO ENGINEER - 1</p>	<p>Checked: ENGR. JUSTINE S. ESPERITO ENGINEER IV</p>	<p>Recommended for Approval: ENGR. MAGNOLA B. ANTONIO-EMM OIC/CITY ENGINEER</p>	<p>Approved as to Plans and Specifications: HON. BENJAY GUSTILO CITY MAYOR</p>	<p>Submitted: A3 5</p>
---	---	---	--	--	---	---------------------------------------

CERTIFIED *Magnola B. Antonio-Emm* **COPY**

0.40mm thick, PRE-PAINTED, RIB TYPE GALVALUME ROOFING SHEETS WITH BENDED RIDGE ROLLS OF THE SAME SPECS

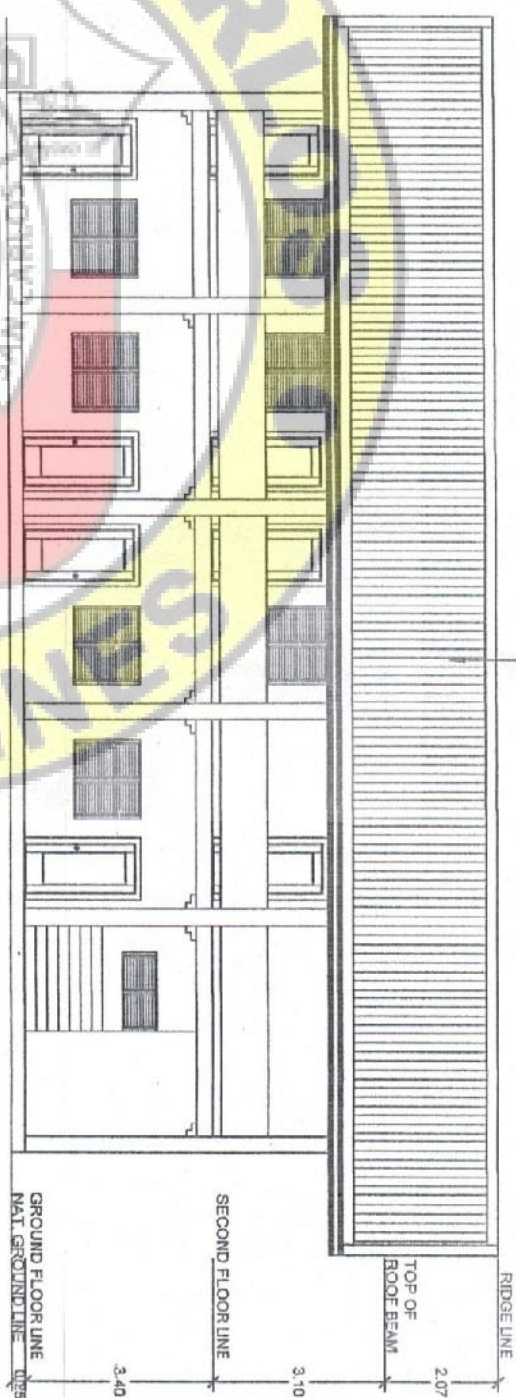

FRONT ELEVATION
SCALE 1:100

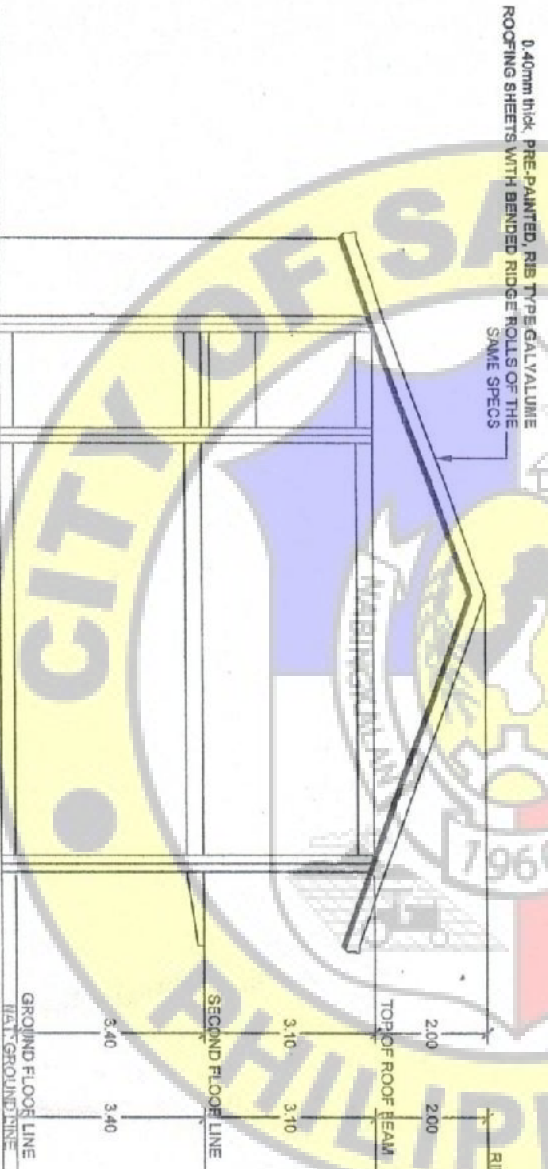

RIGHT SIDE ELEVATION
SCALE 1:100

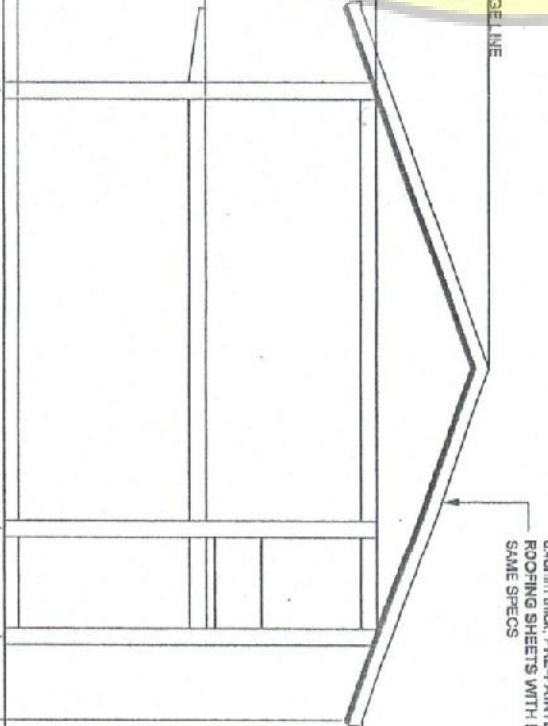

LEFT SIDE ELEVATION
SCALE 1:100



From the office of:		Project Title:		Prepared:		Checked:		Recommended for Approval:		Approved as to Plans and Specifications:		Sheet No.:	
CED		CONSTRUCTION OF TWO CLASSROOM BUILDING @ LINA DELA VINA INTEGRATED SCHOOL		ENGR. JOHN BUR VIRTUCIO ENGINEER - 1		ENGR. JUSTINE J. ELENGITO ENGINEER IV		ENGR. MAGNOLIA B. ALTONG OIC / CITY ENGINEER		HON. RICHARD V. GUSTILO CITY MAYOR		A4 5	
Drafted by: RISHA C. TRELEROS DRAFTSMAN - 1		Location: BRGY. PALAMPANG, SAN CARLOS CITY, NEG OCC.											

COPIED Machine COPY

0.40mm thick, PRE-PAINTED, RIE TYPE GALVALUME
ROOFING SHEETS WITH BENDED RIDGE ROLLS OF THE
SAME SPECS

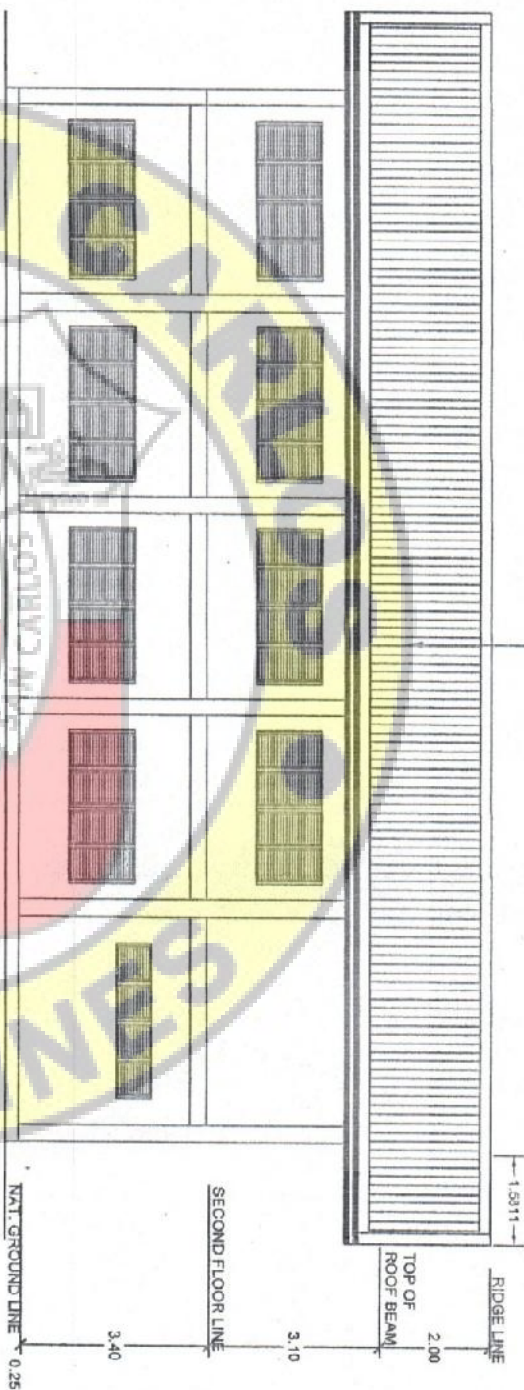

REAR ELEVATION
SCALE 1:100

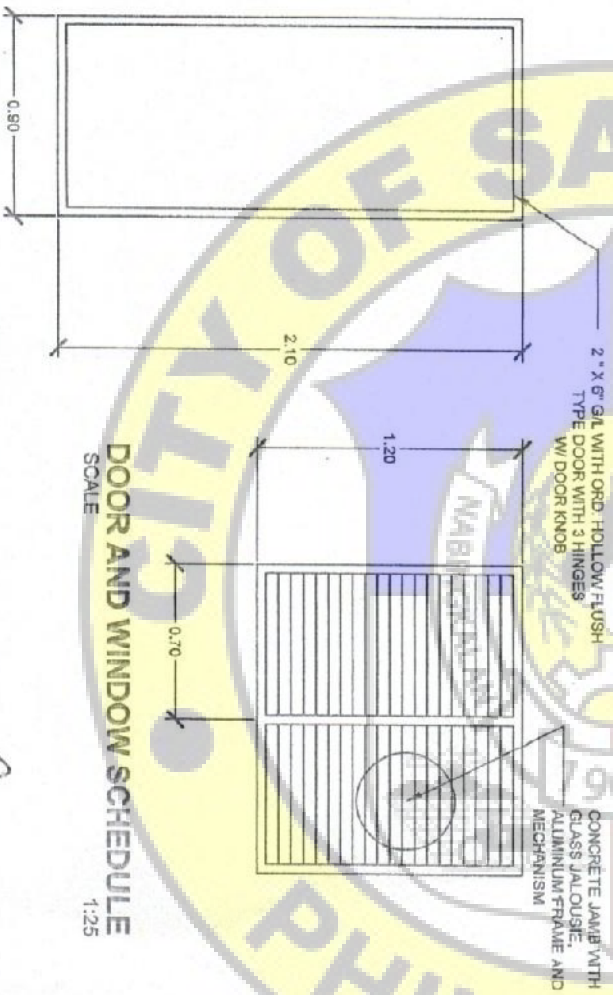

DOOR AND WINDOW SCHEDULE
SCALE 1:25

WALL FOOTING DETAILS
SCALE: 1:25 M.

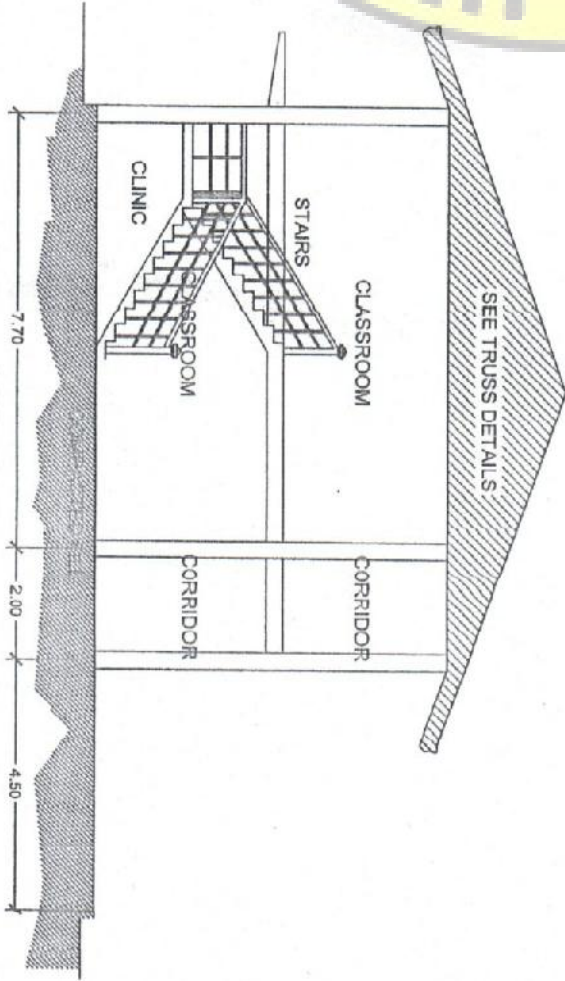
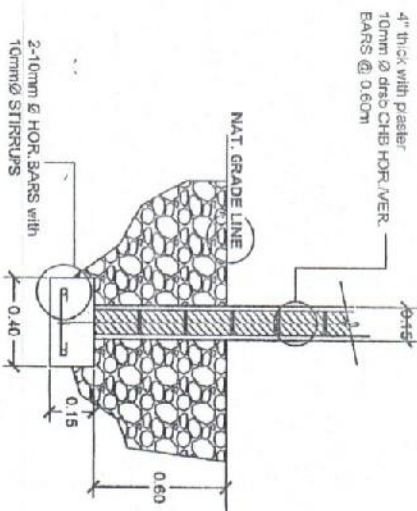

SECTION THRU A-A
SCALE 1:100

From the office of: CED Created by FRANCIS O. TELEROS DRAFTSMAN-1	Project Title: CONSTRUCTION OF TWO CLASSROOM BUILDING @ LINA DELA VINA INTEGRATED SCHOOL Location: Brgy. PALAIPAS, SAN CARLOS DTY., NEG. COC.	Prepared by: ENGR. JOSE M. EUR VIRTUCIO ENGINEER - 1	Checked by: ENGR. JUSTINE M. EJERCITO ENGINEER IV	Recommended for Approval: ENGR. MAGNOLIA B. ANTONIO CIC CITY ENGINEER	Approved as to Plans: HON. HENRY OY. GUSTILO CITY MAYOR
--	--	---	--	--	--



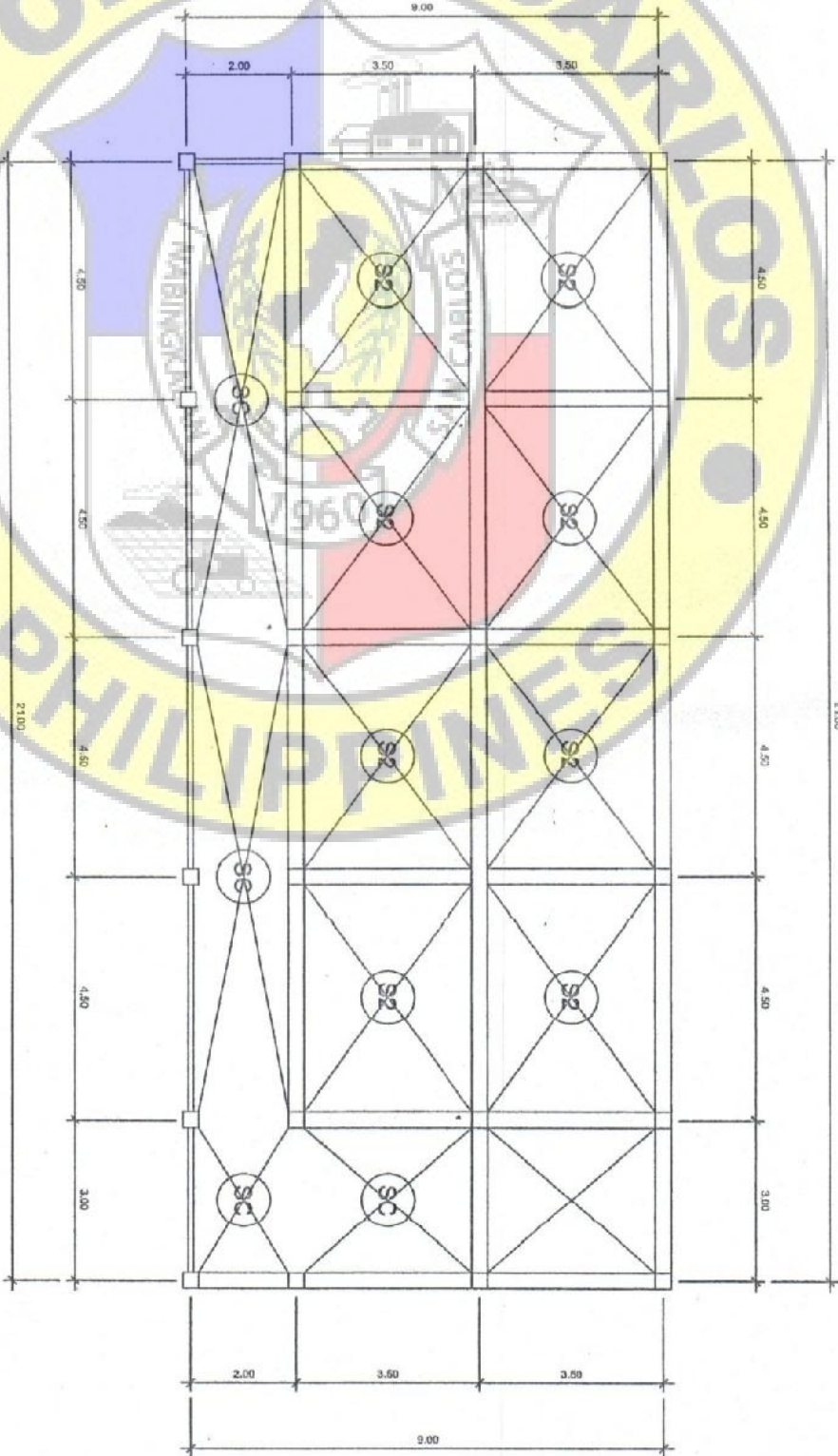

2nd FLOOR SLAB LAYOUT PLAN
SCALE 1:100

From the office of: CED Checked by: TESHA C. TRELENDOS DRAWNSMAN - 1	Project Title: CONSTRUCTION OF TWO CLASSROOM BUILDING @ LINA DELA VINA INTEGRATED SCHOOL Location: BRGY. PALAMPALAN, SAN CARLOS CITY NEG. OCC.	Prepared by: ENGR. JOHN ELM VIRTUCIO ENGINEER - 1	Checked by: ENGR. JUSTINE ELEGANTO ENGINEER IV	Recommended for Approval: ENGR. MAGNOLIA B. ANTONIO OIC/CITY ENGINEER	Approved as to Plans and Specifications: HON. RICHARD Y. GUSTILO CITY MAYOR	Sheet No: S1 of 3
--	---	---	--	---	---	--

CERTIFIED *True and Correct* COPY

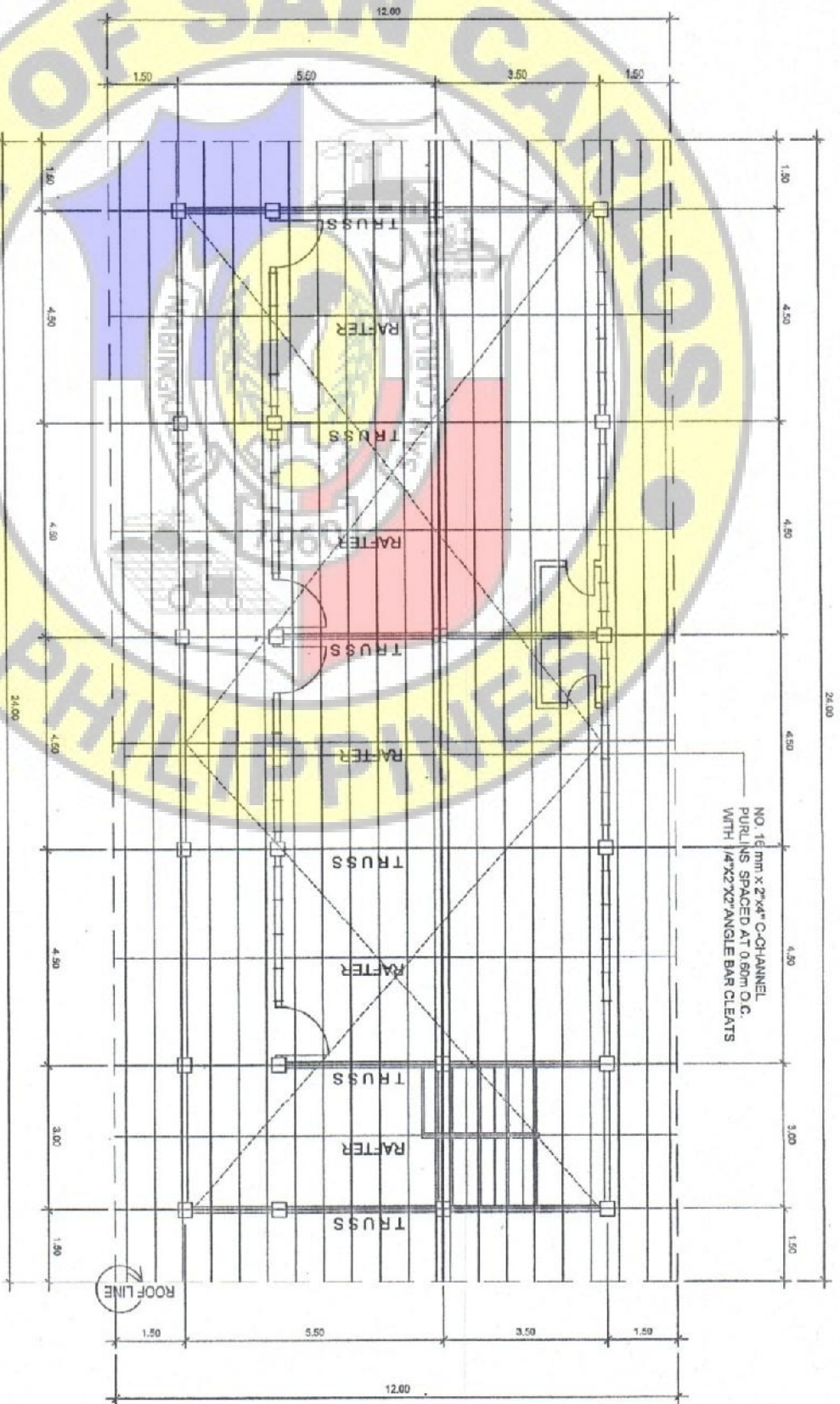
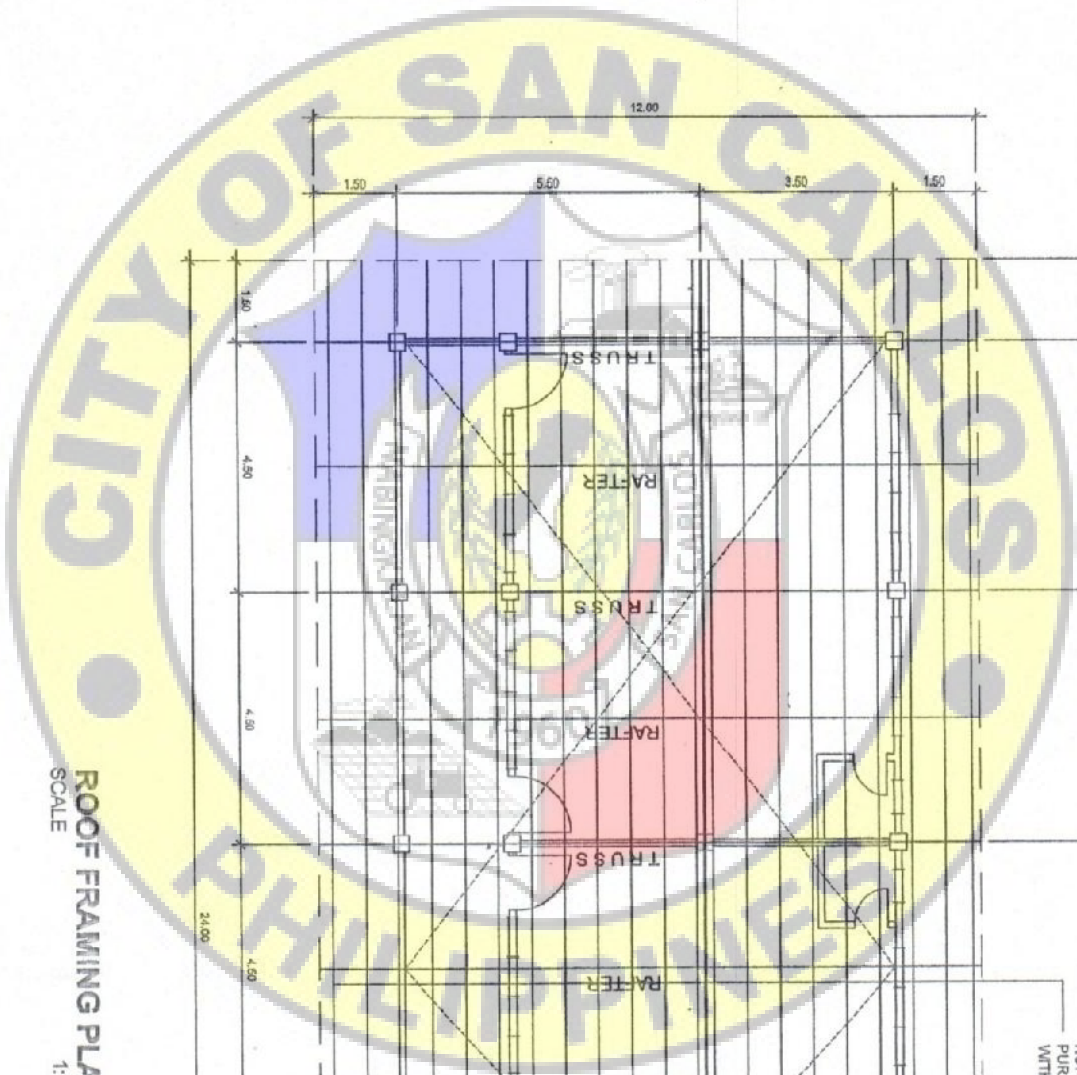

ROOF FRAMING PLAN
SCALE 1:125

CERTIFIED *True and* COPY

From the office of:	Project Title:	Prepared:	Checked:	Recommended for Approval:	Approved as to Plans and Specifications:	Sheet No.
CED Defined by TRISHA C. TELEROS DRAFTSMAN - 1	CONSTRUCTION OF TWO CLASSROOM BUILDING @ LINA DELA VERA INTEGRATED SCHOOL Location: BRGY. PALAMPAS, SAN CARLOS CITY NEG. OCC.	ENGR. JOHN NEURRITURCIC ENGINEER - 1	ENGR. JUSTINE T. EJERCITO ENGINEER IV	ENGR. MAGNOLIBA ANTONIO-EMP OIC / CITY ENGINEER	HON. SENATOR V. GUSTILO CITY MAYOR	S2 3

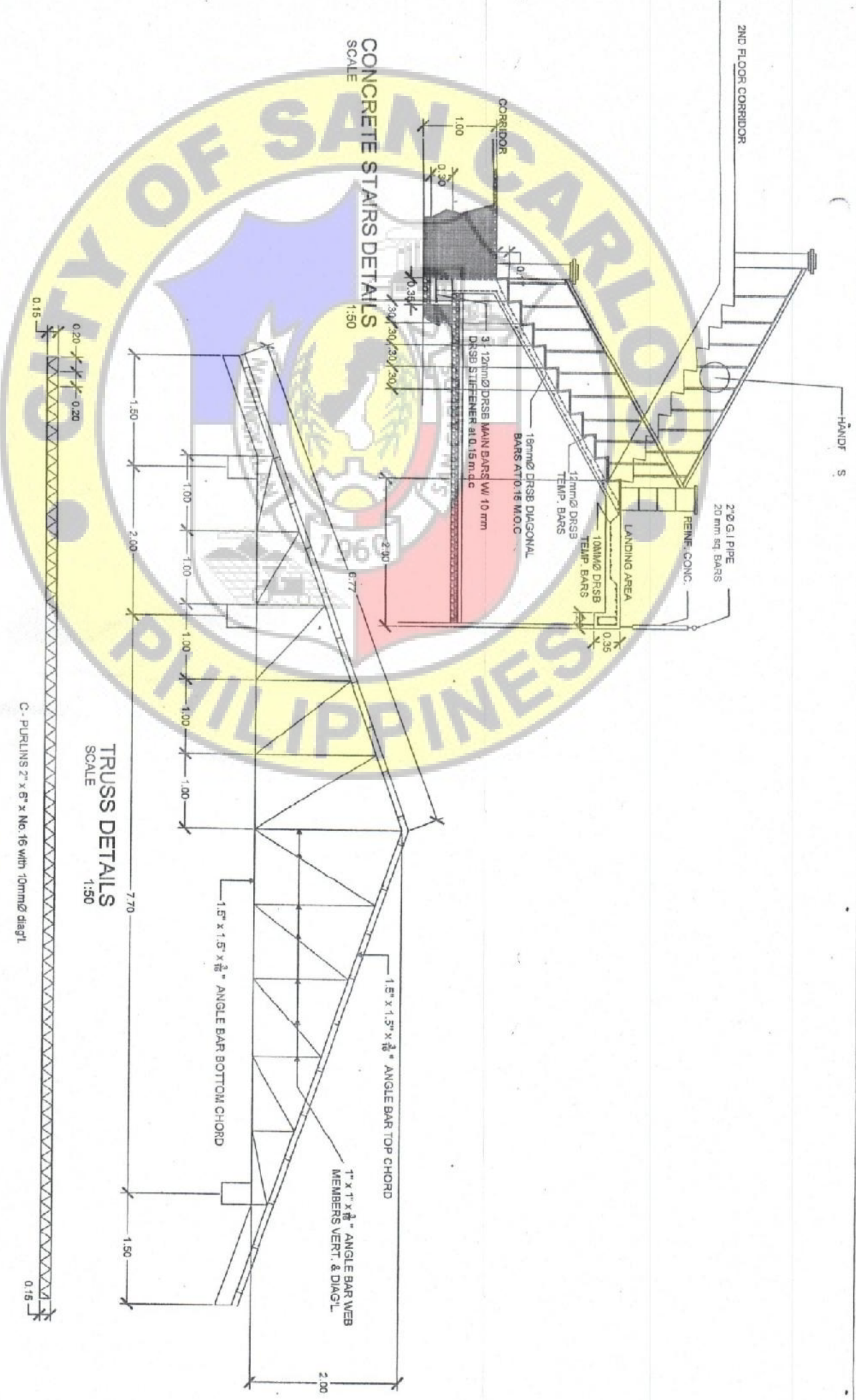

From the office of:	Project Title:	Prepared:	Checked:	Recommended for Approval:	Approved as to Plans and Specifications:
CEED	CONSTRUCTION OF TWO CLASSROOM BUILDING @ LINA DELA VINA INTEGRATED SCHOOL	ENGR. JOHN LEUR VIRTUCIO ENGINEER - 1	ENGR. JUSTINE S. EJERICTO ENGINEER IV	ENGR. MADONNA B. ANTONIO, ENP CITY ENGINEER	ENGR. REYNOLDO Y. GUSTILLO CITY MAYOR
Drawn by: TISHA C. TREASOS DRAFTSMAN - 1	Location: BRGY. PALAMPIG SAN CARLOS CITY, NEG. OCC.				

CERTIFIED
True and Correct
Copies

S3
3

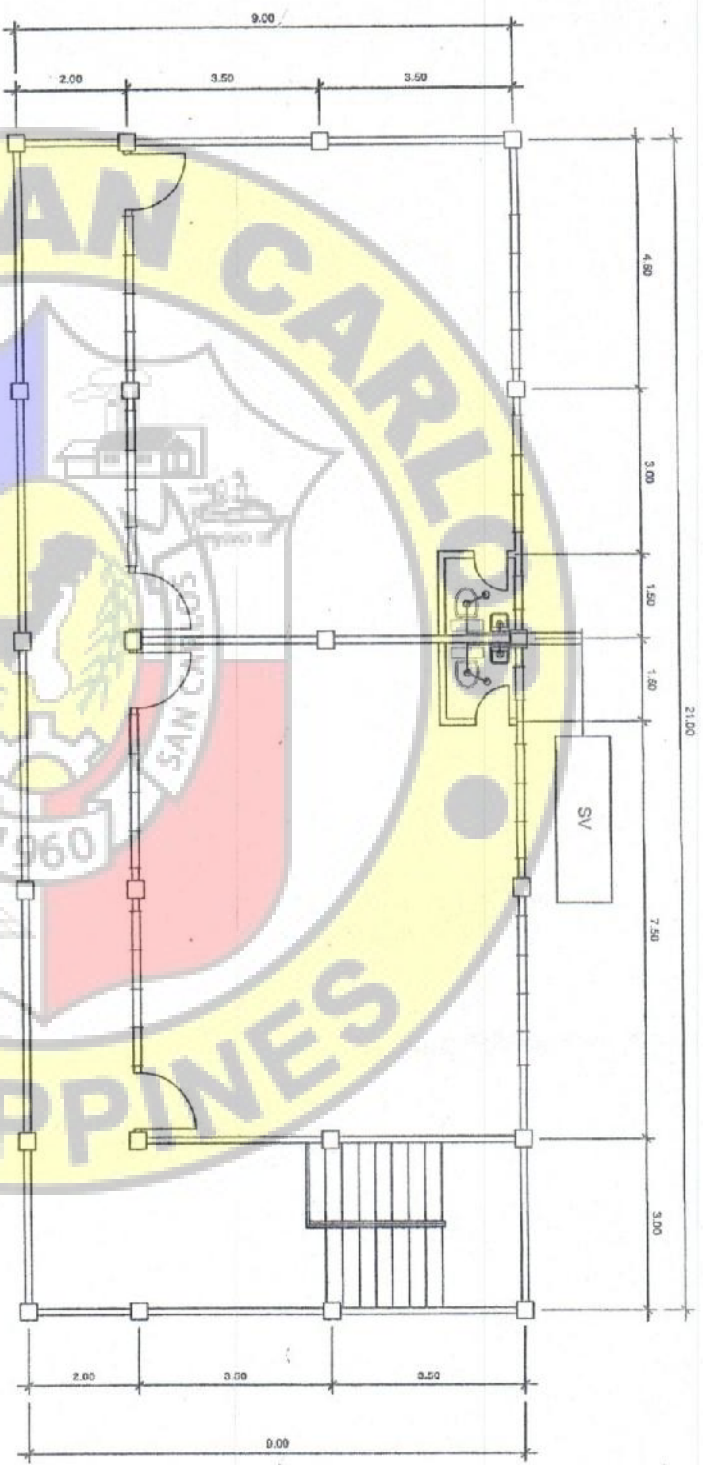

LEGEND

- SV SEPTIC VAULT
- SP SANITARY PIPE
- WC WATER CLOSET
- SK SINK
- FAU FAUCET
- VTR VENT THRU ROOF
- CO CLEAN OUT
- MH MANHOLE
- HH HANDHOLE
- SOIL PIPELINE
- WATER SUPPLY LINE

GENERAL NOTES :

ALL WORKS HEREIN SHALL CONFORM TO THE LATEST EDITION OF THE NATIONAL PLUMBING CODE AND LOCAL ORDINANCE GOVERNING THE INSTALLATION OF PLUMBING WORKS.

ALL SLOPES INDICATED FOR HORIZONTAL BRANCHES SHALL MAINTAIN A MINIMUM OF TWO (2%) PERCENT SLOPE OR AS OTHERWISE INDICATED.

LOCATION OF PIPES MAYBE TRANSFERRED WHENEVER REQUIRED FOR PROPER INSTALLATION AND EXECUTION OF WORKS ON CONDITIONS THAT SUCH CHANGES MEETS THE REQUIREMENTS OF THE ARCHITECT AND OR THE CIVIL ENGINEER.

ALL PLUMBING WORKS TO BE DONE AND SIZES OF PIPES TO BE USED SHALL BE IN ACCORDANCE WITH THE NATIONAL PLUMBING CODE OF THE PHILIPPINES.

ANY AND ALL WORKS INVOLVED IN PROVIDING SANITARY, PLUMBING, DRAINAGE AND SEWER SYSTEM SHALL COMPLY WITH THE REQUIREMENTS OF ALL APPLICABLE LAWS OF THE LOCAL ENFORCING AGENCIES AND OR AUTHORITIES.

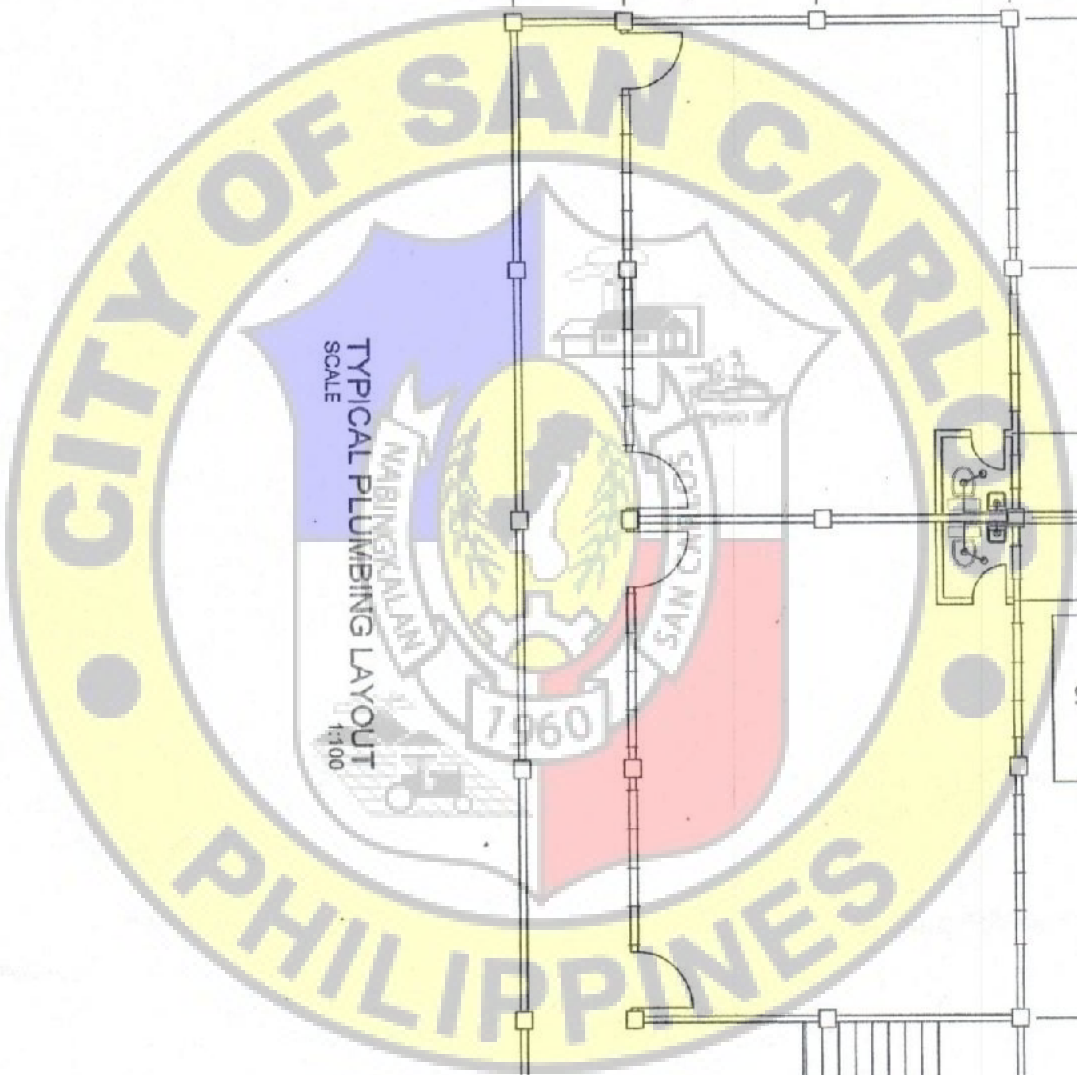

TYPICAL PLUMBING LAYOUT
SCALE 1:100

From the office of:

CED

Created by: TRISHA C. TRISEROS
DRAFTSMAN - 1

Project Title: CONSTRUCTION OF TWO CLASSROOM BUILDING @ LINA DELA VINA INTEGRATED SCHOOL

Location: BRGY. PALAYAN, SAN CARLOS CITY, NEG. OCC.

Prepared by: ENGR. JOHN LEON VIRTUCIO
ENGINEER - 1

Checked by: ENGR. JUSTINE J. EJERCITO
ENGINEER IV

Recommended for Approval: ENGR. MAGNOLIE B. ANTONIO
OIC / CIVIL ENGINEER

Approved as to Plans and Specifications: HON. RICHARD Y. GUSTILO
CITY MAJOR

Stamp No.: **P1**
2

COPIES

12mm Ø DRSB MAT BARS
Spaced at 0.15m

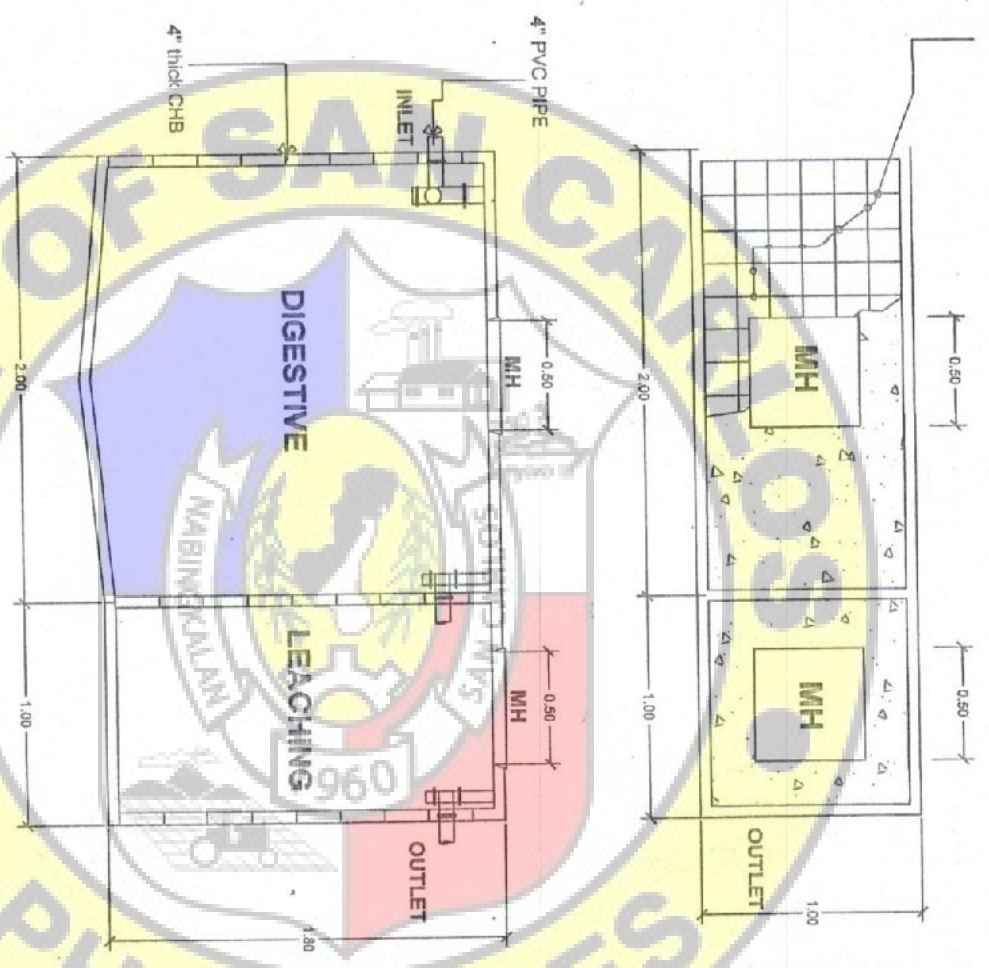

SEPTIC TANK DETAILS
SCALE 1:50

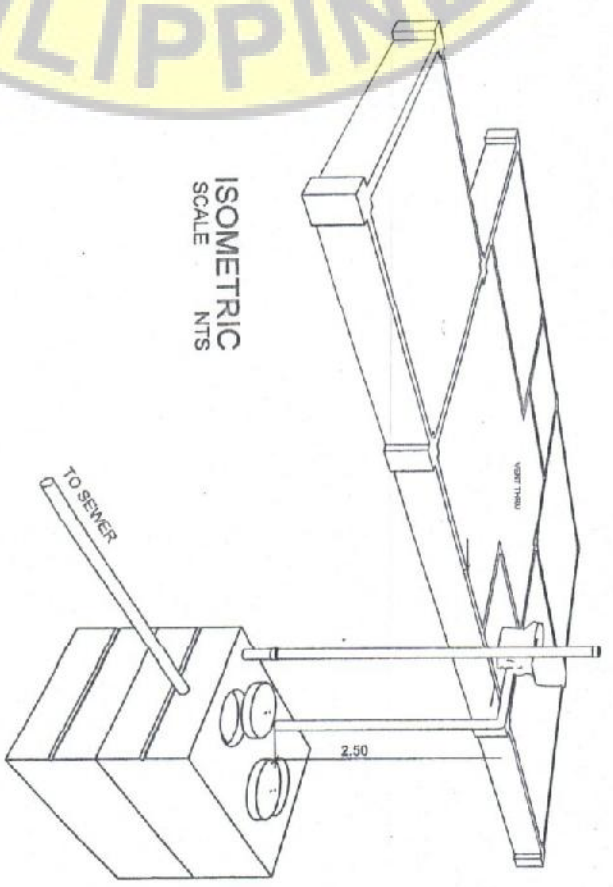

ISOMETRIC
SCALE NTS

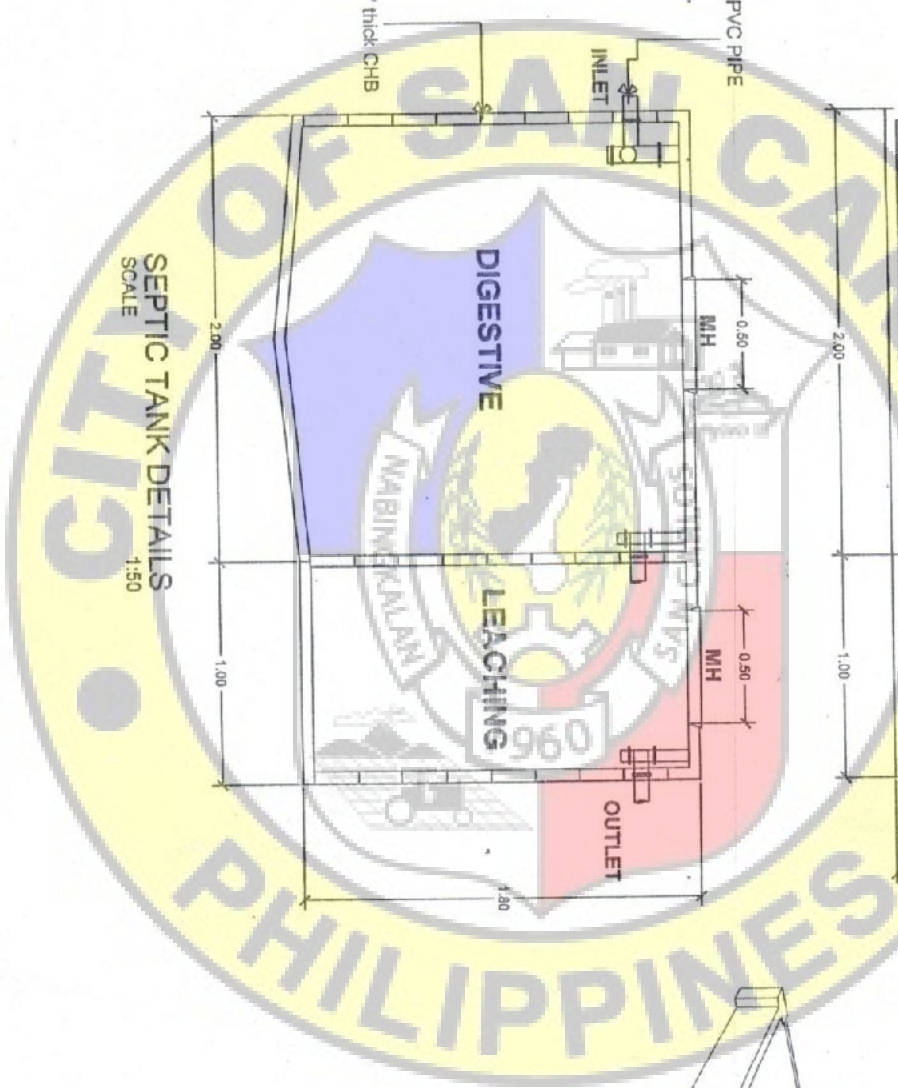

From the office of: CED Directed by: YESSA C. TRAFEROS DIRECTOR - 1	Project Title: CONSTRUCTION OF TWO CLASSROOM BUILDING @ LINA DELA VINA INTEGRATED SCHOOL	Prepared: ENGR. JOHN LEUR VIRTUCIO ENGINEER - 1	Checked: ENGR. JUSTINE J. ENRICO ENGINEER IV	Recommended by/Approved: ENGR. MAGNOLIA B. ANTONIO, ENR. OIC / CITY ENGINEER	Approver as to Plans and Specifications: FON-REMY Y. GUSTILO CITY MAYOR	Checked by: P2 2
--	---	---	--	--	---	------------------------

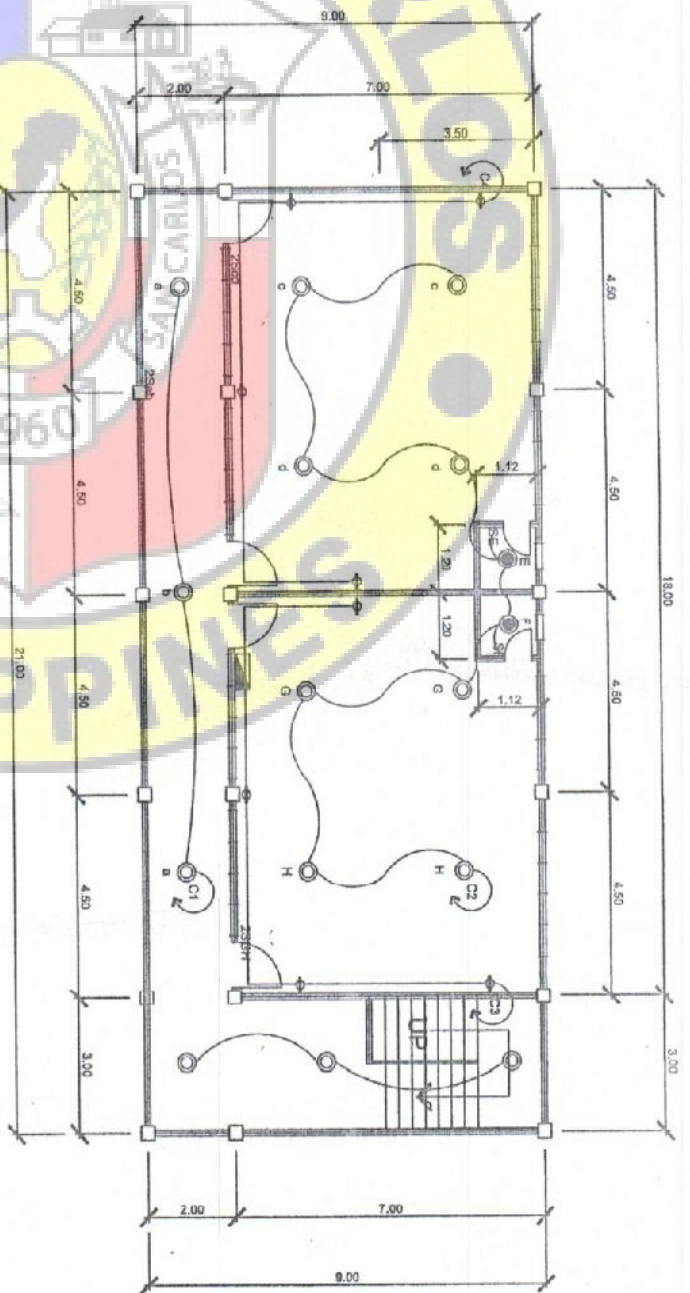

ELECTRICAL LAYOUT
SCALE 1:50

GENERAL NOTES:

- ALL ELECTRICAL WORKS HEREIN SHALL BE IN ACCORDANCE WITH THE LATEST EDITION OF THE PHILIPPINES ELECTRICAL CODE, THE CITY ORDINANCE, THE BUREAU OF FIRE PROTECTION, AND THE RULES AND THE REGULATION OF THE LOCAL UTILITY COMPANY.
- ALL ELECTRICAL WORKS HEREIN MUST BE DONE UNDER THE DIRECT SUPERVISION OF A DULY REGISTERED MASTER ELECTRICIAN (RME) OR ELECTRICAL ENGINEER (REE).

LEGEND:

- | | | | |
|--|---------------------------------|--|--------------------------------|
| | POWER PANEL | | SINGLE SNAP SWITCH, FLUSH TYPE |
| | KILOWATT HOUR METER | | DUPLEX SNAP SWITCH, FLUSH TYPE |
| | 9W LED BULB, E27, (COOL WHITE) | | 3 WAY SNAP SWITCH, FLUSH TYPE |
| | 18W LED BULB, E27, (COOL WHITE) | | CIRCUIT BREAKER, 2P, 220 VAC |
| | 10 A. DUPLEX CONV. OUTLET | | CIRCUIT LINE |
| | | | CIRCUIT HOMERUN |

From the office of:	Project Title:	Prepared by:	Checked by:	Recommended for Approval:	Approved as to Plans and Specifications:	Sheet No.:
CED TRIGLA, C. TREEROS DRAFTSMAN - 1	CONSTRUCTION OF TWO CLASSROOM BUILDING @ LINA DELA VINA INTEGRATED SCHOOL	ENGR. JOHN LEUR VIRTUCIO ENGINEER - 1	ENGR. JUSTINE J. ESPERITO ENGINEER IV	ENGR. MAGNOLIA B. ANTONIO, ENP CITY ENGINEER	HON. BERNARDO Y. GUSTILO CITY MAYOR	E1 2
	Location: BRGY. PALAMAS, SAN CARLOS CITY, NEG. OCC.					

CEDEP
MAGNOLIA B. ANTONIO
COPY

SINGLE LINE DIAGRAM

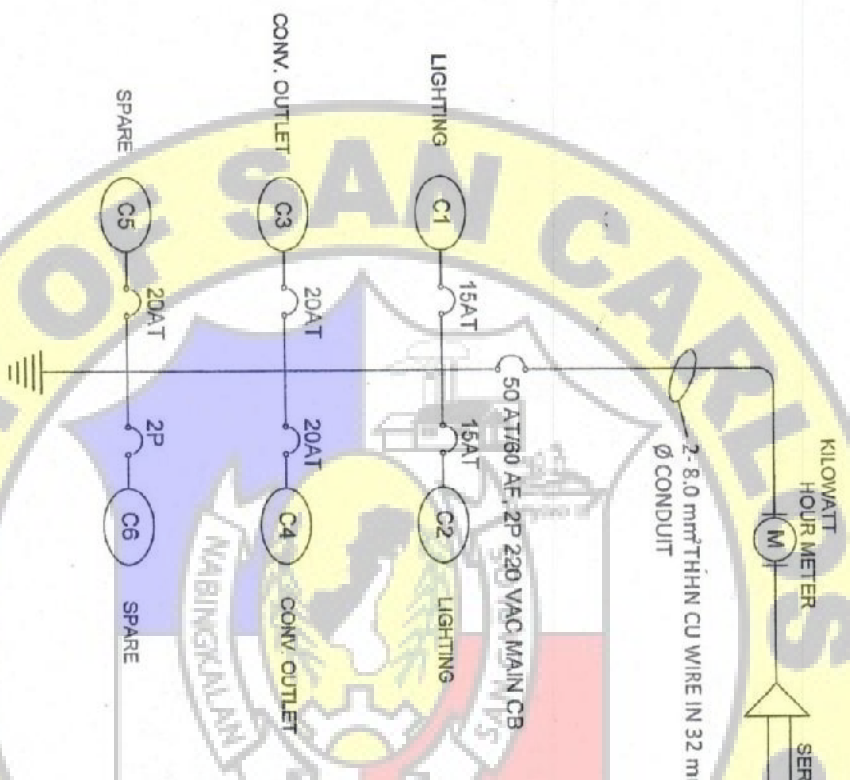

LOAD TABULATION :

CIRCUIT NUMBER	DESCRIPTION	NO. OF FIXTURES	VA / CKT.	AMPS/ CKT.	ACB RATING	PHASE	VOLTS	SIZE OF WIRES
C1	LIGHTING OUTLET						220 V	USE 2- 3.5 MM² THHN CU WIRE STRANDED IN 20 MMØ UPVC CONDUIT
C2	LIGHTING OUTLET						220 V	USE 2- 3.5 MM² THHN CU WIRE STRANDED IN 20 MMØ UPVC CONDUIT
C3	CONV. OUTLET						220 V	USE 2- 3.5MM² TW /AWG STRANDED WIRE IN 20MMØ PVC CONDUIT PPE
C4	CONV. OUTLET						220 V	USE 2- 3.5MM² TW /AWG STRANDED WIRE IN 20MMØ PVC CONDUIT PPE
SPARE	SPARE						220 V	
TOTAL							220 V	



DELETED *Handwritten* COPY

From the office of : **CEED**
 Created by : **TRISHA C. TRILASAS**
 BRANFTSMAAN - 1

Project Title : **CONSTRUCTION OF TWO CLASSROOM BUILDING @ LINA DELA VINA INTEGRATED SCHOOL**
 Location : **BRGY. PALAMPAN SAN CARLOS CITY, NEG OCC.**

Prepared by : **ENGR. JOY TEUR VIRTUCIO**
 ENGINEER - 1

Checked by : **ENGR. JUSTINE L. EJERCITO**
 ENGINEER IV

Recommended for Approval : **ENGR. MAGNOLIBA ANTONIO GANAP**
 OIC / CITY ENGINEER

Approved as to Plans and Specifications : **HON. REMANDO V. GUSTILO**
 CITY MAYOR

Sheet No. : **E2**
 2